

## Standards-based cylinders DSBC, ISO 15552

**FESTO**

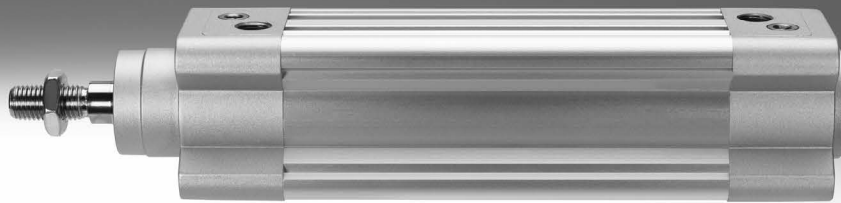

Festo Core Range  
Solves the majority of your automation tasks

Worldwide: Quickest delivery – wherever, whenever  
Simply good: Expected high Festo quality  
Fast: Easy and fast to select

With the Festo Core Range, we have selected the most important products and functions from our broad product catalogue, and added the quickest delivery.  
The Core Range offers you the best value for your automation tasks.

Just look  
for the  
star!

## Characteristics

### At a glance



- Standards-based cylinders to ISO15552 (corresponds to the withdrawn standards ISO 6431, DIN ISO 6431, VDMA24562, NFE49003.1 and UNI 10290)

- Double-acting
- For contactless position sensing
- Optionally with protection against rotation
- EX4: for use in potentially explosive areas
- Extensive range of accessories makes it possible to install the cylinder virtually anywhere
- Three types of cushioning available:
  - Elastic cushioning: elastic cushioning rings/plates at both ends
  - PPS cushioning: pneumatic cushioning, self-adjusting at both ends
  - PPV cushioning: pneumatic cushioning, adjustable at both ends
- The variants can be configured according to individual needs using a modular product system
- Wide range of variants provides high level of flexibility

### DSBC-...-C – with clamping unit, standard hole pattern

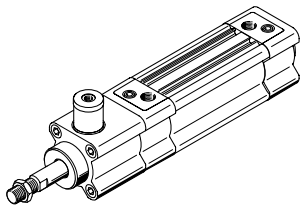

- Standard hole pattern
- Piston rod can be held or clamped in any position
- The piston rod can be held in position for long periods even with alternating loads, fluctuating operating pressure or leaks in the system

Additional measures are required for use in safety-related applications; in Europe, for example, the standards listed under the EC Machinery Directive must be observed.

Without additional measures in accordance with legally specified minimum requirements, the product is not suitable as a safety relevant component in control systems.

### DSBC-...-E1/-E2/-E3 – with end-position locking, standard hole pattern

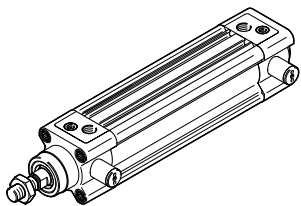

- Standard hole pattern
- Positive locking in the end position as a drop guard. In the event of a pressure drop, the piston rod is locked in its end position.
- Optionally at one or both ends

Additional measures are required for use in safety-related applications; in Europe, for example, the standards listed under the EC Machinery Directive must be observed.

Without additional measures in accordance with legally specified minimum requirements, the product is not suitable as a safety relevant component in control systems.

### DSBC-...-P2 – with bellows kit DADB, standard hole pattern

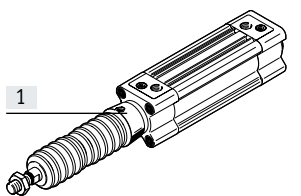

The bellows protects the piston rod, the seal and the bearing from the effects of a wide range of media, which has a positive impact on the service life of these components.

The bellows kit is a leak-free system. To prevent unwanted media from being drawn in, the supply and exhaust air for the kit must be ducted via a pressure compensation hole in the connection part [1].

The kit protects the piston rod, seal and bearing against a wide variety of media, for example:

- Dust
- Chippings
- Oil
- Grease
- Fuel

### Ordering the bellows kit

An extended piston rod is absolutely essential if a bellows kit is to be used. The bellows kit can be ordered via the modular product system or as an accessory. The following must be noted in this case:

#### Ordering via the modular product system:

The bellows kit is supplied mounted on the bearing cap using feature P2. The required piston rod extension is automatically taken into consideration. This means that there is no need to specify a value for feature ...E.

#### Ordering as an accessory:

If the bellows kit is ordered as an accessory, the required value → page 51 must be entered for feature ...E in the modular product system.

## Characteristics

### DSBC... D3 – Sensor slots on 3 sides

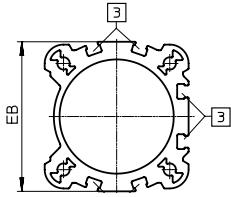

The piston position can be sensed on 3 sides of the drive if feature D3 is selected in the modular product system.

[3] Sensor slot for proximity switch

### Position sensing/force control

With position transmitter SMAT-8M, SMAT-8E, SDAT → page 61



Analogue position feedback possible

- Analogue output
  - 0 ... 10 V
  - 0 ... 20 mA

With proportional-pressure regulator VPPM



Infinite adjustment of the gripping force possible

- Setpoint value input
  - 0 ... 10 V
  - 4 ... 20 mA

### For manufacturing lithium-ion batteries

DSBC...-F1A

Recommended for production facilities for the manufacture of lithium-ion batteries.

Metals with copper, zinc or nickel as the main constituent are excluded from use. Exceptions are nickel in steels, chemically nickel-plated surfaces, printed circuit boards, cables, electrical plug connectors and coils.

### Accessories

Your Festo contact partner can provide information about which accessories are suitable for manufacturing lithium-ion batteries.

### Optional accessories

Mounting kit DAVM

→ Page 1

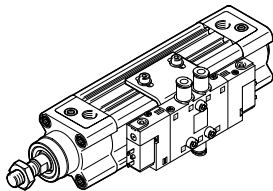

- For lateral valve mounting, directly on the drive
- Particularly suitable for decentralised use in large systems
- Mounting is only possible on the side on which the pneumatic connections are located

### Application examples



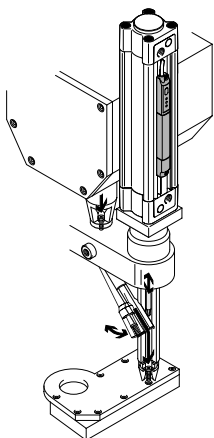



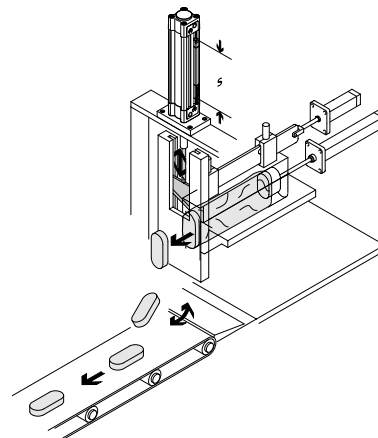

Automatic screw machine











For process control

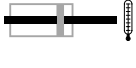

## Characteristics

Variants from the modular product system		
Symbol	Characteristics	Description
	Q Square piston rod	Protection against rotation. For correctly oriented feeding
	C Clamping unit	Integrated clamping unit on the piston rod
	E1/E2/E3 End-position locking	Positive locking in the end position as a drop guard. If there is a drop in pressure, the piston rod is secured in its end position to prevent it from dropping
	L Low friction	<ul style="list-style-type: none"> <li>• Break-away pressure: low</li> <li>• Dynamic response: Suitable for very fast movements, especially at low operating pressures</li> </ul> Application example: Very dynamic movements with no standstill
	U Constant, slow movement	<ul style="list-style-type: none"> <li>• Break-away pressure: very low</li> <li>• Dynamic response: Suitable for very slow, constant and stick-slip-free movements</li> </ul> Application example: Slow, constant feed motion
	L1 Low friction for balancer applications	<ul style="list-style-type: none"> <li>• Break-away pressure: low</li> <li>• Dynamic response: Suitable for slow movements with constant application of pressure at one end. System friction is independent of operating pressure</li> </ul> Application example: Applications for load balancing (balancer, belt tensioner with constant feed motion)
	T Through piston rod	For working at both ends with the same force in the forward and return stroke, for attaching external stops
	F Female piston rod thread	–

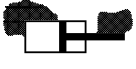
## Characteristics

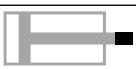
Variants from the modular product system		
Symbol	Characteristics	Description
	R3 High corrosion protection	All external cylinder surfaces comply with corrosion resistance class 3 to Festo standard 940070. The piston rod is made from corrosion- and acid-resistant steel
	T1 Heat-resistant seals	Temperature range 0 ... +120°C
	T3 Low temperature	Temperature range -40 ... +80°C
	T4 Heat-resistant seals	Temperature range 0 ... +150°C
	A1 Scraper variant	Increased chemical resistance: For longer service life, e.g. when using cooling lubricants.
	A2 Wiper variant	Hard wiper: The cylinder is equipped with a hard-chrome plated piston rod and a hard scraper, which protects against dry, dusty and viscous media
	A3 Wiper variant	Unlubricated operation: Cleaning processes degrease the piston rod. A special piston rod seal designed for unlubricated operation permits a longer service life compared to the standard seal
	A6 Scraper variant	Metal wiper: The cylinder is fitted with a hard-chrome plated piston rod and metal scraper, which scrapes off hard particles (e.g. welding spatter) sticking to the piston rod. Application: Use in welding equipment
	...E Extended piston rod	-
	...L Extended piston rod thread	-

Product range overview

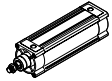
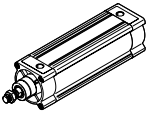
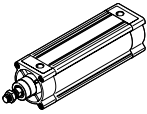
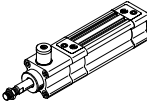
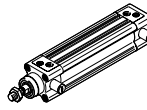
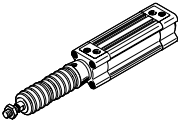
Function	Version	Type	Piston diameter	Stroke	Through piston rod	Female piston rod thread	Sensor slot on 3 sides	Cushioning	PPS	PPV	
			[mm]	[mm]							
Double-acting	<b>DSBC-...</b>										
		DSBC-...	32, 40, 50, 63, 80, 100, 125	1 ... 2800		■	■	■	■	■	■
	<b>DSBC-...-Q – with protection against rotation</b>										
		DSBC-...-Q	32, 40, 50, 63, 80, 100	1 ... 1500		■	■	■	■	■	■
	<b>DSBC-...-L/-U/-L1 – with special running characteristics</b>										
		DSBC-...-L	32, 40, 50, 63, 80, 100	1 ... 2800		-	■	■	■	■	■
		DSBC-...-U	32, 40, 50, 63, 80, 100, 125	1 ... 2800		-	■	■	■	■	■
		DSBC-...-L1	32, 40, 50, 63, 80, 100, 125	10 ... 1000		-	■	■	■	■	-
	<b>DSBC-...-C – with clamping unit, standard hole pattern</b>										
		DSBC-...-C	32, 40, 50, 63, 80, 100, 125	10 ... 2000		■	■	■	■	■	■
<b>DSBC-...-E1/-E2/-E3 – with end-position locking, standard hole pattern</b>											
	DSBC-...-E1/-E2/-E3	32, 40, 50, 63, 80, 100	10 ... 2000		-	■	■	■	-	■	
<b>DSBC-...-P2 – with bellows, standard hole pattern</b>											
	DSBC-...-P2	32, 40, 50, 63, 80, 100	10 ... 500		■	■	■	■	■	■	

## Product range overview

Type	Position sensing	High corrosion protection	Temperature range 0 ... +120°C	Temperature range -40 ... +80°C	Temperature range 0 ... +150°C	Scrapper variant increased chemical resistance	Scrapper variant hard scrapper	Scrapper variant for unlubricated operation	Scrapper variant metal scrapper	EU certification	Piston rod extension	Extended piston rod thread
	A	R3	T1	T3	T4	A1	A2	A3	A6	EX4	...E	...L
<b>DSBC...</b>												
DSBC...	■	■	■	■	■	■	■	■	■	■	■	■
<b>DSBC...-Q – with protection against rotation</b>												
DSBC...-Q	■	■	■	-	-	-	-	-	-	■	■	■
<b>DSBC...-L/-U/-L1 – with special running characteristics</b>												
DSBC...-L	■	-	-	-	-	-	-	-	-	-	■	■
DSBC...-U	■	-	-	-	-	-	-	-	-	-	■	■
DSBC...-L1	■	-	-	-	-	-	-	-	-	-	■	■
<b>DSBC...-C – with clamping unit, standard hole pattern</b>												
DSBC...-C	■	-	-	-	-	-	-	-	-	-	■	■
<b>DSBC...-E1/-E2/-E3 – with end-position locking, standard hole pattern</b>												
DSBC...-E1/ E2/-E3	■	-	-	-	-	-	-	-	-	-	■	■
<b>DSBC...-P2 – with bellows, standard hole pattern</b>												
DSBC...-P2	■	■	-	-	-	-	-	-	-	-	■	■

## Peripherals overview

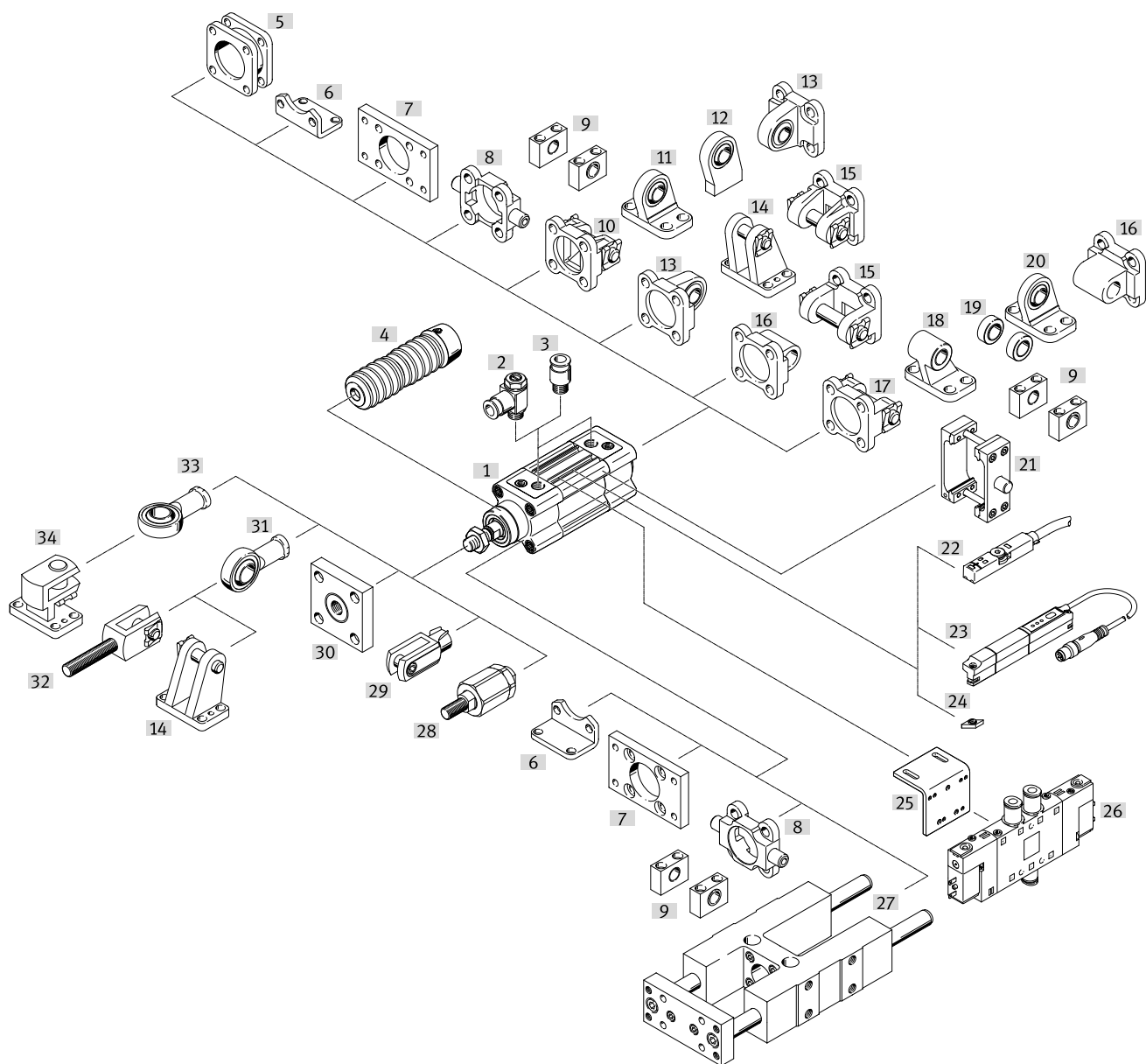

Mounting components and accessories		Description	DSBC...-					→ Page/ Internet
				L/U/ L1	C	E1/E2/ E3	T	
[1]	Standards-based cylinder DSBC	Standards-based cylinder without accessories, basic design						11
[2]	One-way flow control valve GRLA	For speed regulation	■	■	■	■	■	62
[3]	Push-in fitting QS	For connecting compressed air tubing with standard O.D.	■	■	■	■	■	qs
[4]	Bellows kit DADB	<ul style="list-style-type: none"> <li>Protects the cylinder (piston rod, seal and bearings) against a wide range of media and thus prevents premature wear</li> <li>Can only be used in combination with an extended piston rod (E)</li> </ul>	■	-	-	-	■	51
[5]	Multi-position kit DPNC	For connecting two cylinders with identical piston diameters to form a multi-position cylinder	■	-	■	■	■	55
[6]	Foot mounting HNC/CRHNC	For bearing or end caps	■	■	■	■	■	40

- 1) Cannot be mounted in combination with E1.  
 Can only be mounted on the end cap in combination with E2.  
 Can only be mounted on the bearing cap in combination with E3.



## Peripherals overview

	Description	DSBC-...					→ Page/ Internet	
			L/U/ L1	C	E1/E2/ E3	T		
[7]	Flange mounting FNC/CRFNG	<ul style="list-style-type: none"> <li>For bearing or end caps</li> <li>Cannot be used on the bearing cap in combination with the bellows kit DADB</li> </ul>	■	■	■	■	■	41
[8]	Trunnion flange ZNC/CRZNG	<ul style="list-style-type: none"> <li>For bearing or end caps</li> <li>Cannot be used on the bearing cap in combination with the bellows kit DADB</li> </ul>	■	■	■	■ <sup>1)</sup>	■	42
[9]	Trunnion support LNZG/CRLNZG	–	■	■	■	■ <sup>1)</sup>	■	43
[10][15]	Swivel flange SNC	For end caps	■	■	■	■	–	44
[11]	Clevis foot LSNG	With spherical bearing	■	■	■	■	–	49
[12]	Clevis foot LSNSG	Weld-on, with spherical bearing	■	■	■	■	–	49
[13]	Swivel flange SNCS/CRSNCS/SNCS-...-R3	With spherical bearing for end caps	■	■	■	■	–	46
[14]	Clevis foot LBG/LBG-...-R3	–	■	■	■	■	–	49
[16]	Swivel flange SNCL	For end caps	■	■	■	■	–	47
[17]	Swivel flange SNCB/SNCB-...-R3	For end caps	■	■	■	■	–	45
[18]	Clevis foot LNG/CRLNG	–	■	■	■	■	–	49
[19][20]	Clevis foot LSN	With spherical bearing	■	■	■	■	–	49
[21]	Trunnion flange kit DAMT	For mounting anywhere along the cylinder profile barrel	■	■	■	■	■	48
[22]	Proximity switch SME/SMT-8M/SDBT-MS	Can be integrated in the cylinder profile barrel	■	■	■	■	■	60
[23]	Position transmitter SMAT, SDAT	<ul style="list-style-type: none"> <li>Continuously senses the position of the piston</li> <li>Has an analogue output</li> </ul>	■	■	■	■	■	61
[24]	Slot nut ABAN	Inserted in slot from above	■	■	■	■	■	62
[25]	Mounting kit DAVM	For mounting the valve	■	■	■	■	■	56
[26]	Solenoid valve CPE/VUVG/VUVS	For standards-based cylinder	■	■	■	■	■	56
[27]	Guide unit FENG	For protecting standards-based cylinders against rotation at high torque loads	■	■	■	–	■	59
[28]	Self-aligning rod coupler FK, CRFK	For compensating radial and angular deviations	■	■	■	■	■	50
[29]	Rod clevis SG/CRSG	Permits a swivelling movement of the cylinder in one plane	■	■	■	■	■	50
[30]	Coupling piece KSG	For compensating radial deviations	■	■	■	■	■	50
	Coupling piece KSZ	For cylinders with a non-rotating piston rod to compensate for radial deviations	■	■	■	■	■	50
[31][33]	Rod eye SGS/CRSGS	With spherical bearing	■	■	■	■	■	50
[32]	Rod clevis SGA	With male thread	■	■	■	■	■	50
[34]	Right-angle clevis foot LQG	–	■	■	■	■	■	49
–	Slot cover ABP-5-S	For protecting the sensor cable and the sensor slots from contamination	■	■	■	■	■	62

## Type codes

001	Series	
DSBC	Standards-based cylinder, double-acting, based on ISO 15552	

002	Protection against rotation	
	None	
Q	With protection against rotation	

003	Running characteristics	
	Standard	
L	Low friction	
U	Uniform, slow movement	
L1	Low friction for balancer applications	

004	Piston diameter [mm]	
32	32	
40	40	
50	50	
63	63	
80	80	
100	100	
125	125	

005	Stroke [mm]	
20	20	
25	25	
30	30	
40	40	
50	50	
60	60	
70	70	
80	80	
100	100	
125	125	
150	150	
160	160	
200	200	
250	250	
300	300	
320	320	
400	400	
500	500	
...	1 ... 2800	

006	Clamping unit	
	None	
C	Attached	

007	End-position locking	
	None	
E1	Both sides	
E2	With advanced piston rod	
E3	With retracted piston rod	

008	Piston rod type	
	At one end	
T	Through piston rod	

009	Piston rod thread type	
	Male thread	
F	Female thread	

010	Profile type	
D3	Sensor slots on 3 profile sides	
	Sensor slot on one profile side only	

011	Cushioning	
P	Elastic cushioning rings/plates on both sides	
PPS	Pneumatic cushioning, self-adjusting at both ends	
PPV	Pneumatic cushioning, adjustable at both ends	

012	Position sensing	
A	For proximity sensor	

013	Corrosion protection	
	Standard	
R3	High corrosion protection	

014	Temperature range	
	Standard	
T1	Heat-resistant seals max. 120°C	
T3	-40 ... +80°C	
T4	0 ... +150°C	

015	Protection against particles	
	Standard	
P2	Bellows on bearing cap	

016	Scraper variant	
	None	
A1	Increased chemical resistance	
A2	Hard scraper	
A3	For unlubricated operation	
A6	Metal scraper	

017	Special material properties	
	None	
F1A	Recommended for production facilities for the manufacture of lithium-ion batteries	

018	EU certification	
	None	
EX4	II 2GD	

019	Piston rod extension	
	None	
...E	1 ... 500 mm	

020	Piston rod thread extension	
	None	
...L	0 ... 70 mm	

## Data sheet

Function  
Elastic cushioning

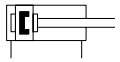

PPV cushioning

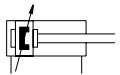

PPS cushioning

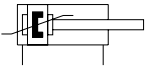

⌀ Diameter  
32 ... 125 mm

— Stroke length  
1 ... 2800 mm



www.festo.com

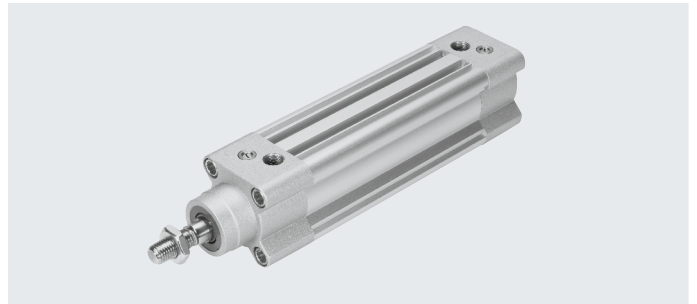

### General technical data

Piston diameter	32	40	50	63	80	100	125
Design	Piston/piston rod/profile barrel						
Mode of operation	Double-acting						
Pneumatic connection	G1/8	G1/4	G1/4	G3/8	G3/8	G1/2	G1/2
Piston rod thread	M10x1.25	M12x1.25	M16x1.5	M16x1.5	M20x1.5	M20x1.5	M27x2
Stroke							
DSBC... [mm]	1 ... 2800						
DSBC...-Q [mm]	1 ... 1500						-
DSBC...-L1 [mm]	10 ... 1000						
DSBC...-C [mm]	10 ... 2000						
DSBC...-E1/-E2/-E3 [mm]	10 ... 2000						-
DSBC...-P2 [mm]	10 ... 500						-
DSBC...-E [mm]	1 ... 2000						
DSBC...-L [mm]	1 ... 2000						
Cushioning							
DSBC...-P	Elastic cushioning rings/plates at both ends						
DSBC...-PPV	Pneumatic cushioning, adjustable at both ends						
DSBC...-PPS	Pneumatic cushioning, self-adjusting at both ends						
Cushioning length							
DSBC...-PPV [mm]	17	19	22	22	31	31	45
DSBC...-E1/-E2/-E3 [mm]	17	19	15	15	15	15	-
Position sensing	Via proximity switch						
Type of mounting	With female thread/accessories						
Mounting position	Any						

## Data sheet

Operating and environmental conditions									
Piston diameter		32	40	50	63	80	100	125	
Operating medium		Compressed air to ISO 8573-1:2010 [7:4:4]							
Note on the operating/pilot medium		Lubricated operation possible (in which case lubricated operation will always be required)							
Operating pressure									
DSBC...	[MPa]	0.06 ... 1.2		0.04 ... 1.2				0.02 ... 1.0	
	[bar]	0.6 ... 12		0.4 ... 12				0.2 ... 10	
DSBC...-L <sup>1)</sup>	[MPa]	0.03 ... 1.2	0.025 ... 1.2		0.02 ... 1.2	0.015 ... 1.2	-		
	[bar]	0.3 ... 12	0.25 ... 12		0.2 ... 12	0.15 ... 12	-		
DSBC...-U <sup>1)</sup>	[MPa]	0.01 ... 1.2		0.005 ... 1.2				0.005 ... 1.0	
	[bar]	0.1 ... 12		0.05 ... 12				0.05 ... 10	
DSBC...-L1 <sup>1)</sup>	[MPa]	0.03 ... 1.2	0.025 ... 1.2		0.02 ... 1.2	0.015 ... 1.2	0.01 ... 1.0		
	[bar]	0.3 ... 12	0.25 ... 12		0.2 ... 12	0.15 ... 12	0.1 ... 10		
DSBC...-C <sup>2)</sup>	[MPa]	0.15 ... 1.0							
	[bar]	1.5 ... 10							
DSBC...-E1/-E2/-E3	[MPa]	0.25 ... 1.2		0.15 ... 1.2				-	
	[bar]	2.5 ... 12		1.5 ... 12				-	
DSBC...-T3/-A2	[MPa]	0.1 ... 1.2						0.1 ... 1.0	
	[bar]	1 ... 12						1 ... 10	
DSBC...-A3	[MPa]	0.15 ... 1.2		0.1 ... 1.2	0.06 ... 1.2			0.06 ... 1.0	
	[bar]	1.5 ... 12		1 ... 12	0.6 ... 12			0.6 ... 10	
DSBC...-A6	[MPa]	0.2 ... 1.2	0.15 ... 1.2				0.15 ... 1.0		
	[bar]	2 ... 12	1.5 ... 12				1.5 ... 10		
Ambient temperature <sup>3)</sup>									
DSBC...	[°C]	-20 ... +80							
DSBC...-L/-U	[°C]	+5 ... +80							
DSBC...-L1	[°C]	0 ... +60							
DSBC...-A1	[°C]	0 ... +80							
DSBC...-A6	[°C]	-20 ... +80							
DSBC...-T1-A6	[°C]	0 ... +120							
DSBC...-T3-A6	[°C]	-40 ... +80							
DSBC...-T4-A6	[°C]	0 ... +150							
DSBC...-C	[°C]	-10 ... +80							
DSBC...-T1	[°C]	0 ... +120							
DSBC...-T3	[°C]	-40 ... +80							
DSBC...-T4	[°C]	0 ... +150							
DSBC...-P2	[°C]	-10 ... +80						-	
DSBC...-EX4	[°C]	-20 ... +60							
Corrosion resistance CRC									
DSBC...		2 <sup>4)</sup>							
DSBC...-R3		3 <sup>5)</sup>							

1) Values apply only for strokes ≤ 500 mm and after 10 double strokes.

In combination with cushioning PPV/PPS, the specifications only apply outside the cushioning range

2) Note min. release pressure → page 19

3) Note operating range of proximity switches.

4) Corrosion resistance class CRC 2 to Festo standard FN 940070

Moderate corrosion stress. Indoor applications in which condensation can occur. External visible parts with primarily decorative surface requirements which are in direct contact with a normal industrial environment.

5) Corrosion resistance class CRC 3 to Festo standard FN 940070

High corrosion stress. Outdoor exposure under moderate corrosive conditions. Externally visible parts with primarily functional surface requirements which are in direct contact with a normal industrial environment.

## Data sheet

<b>Weight [g]</b>							
Piston diameter	32	40	50	63	80	100	125
<b>DSBC...</b>							
Product weight with 0 mm stroke	465	740	1190	1740	2660	3665	6611
Additional weight per 10 mm stroke	27	37	56	62	92	101	151
Moving mass with 0 mm stroke	110	205	365	430	810	1000	2245
Moving mass per 10 mm stroke	9	16	25	25	39	39	63
<b>DSBC...-Q</b>							
Product weight with 0 mm stroke	503	755	1241	1821	2717	3827	–
Additional weight per 10 mm stroke	25	30	51	57	87	95	–
Moving mass with 0 mm stroke	115	170	332	391	757	890	–
Moving mass per 10 mm stroke	8	11	20	20	31	31	–
<b>DSBC...-C</b>							
Product weight with 0 mm stroke	745	1175	1940	2920	5075	6965	12860
Additional weight per 10 mm stroke	25	35	56	62	95	103	151
Moving mass with 0 mm stroke	160	290	540	620	1200	1425	3035
Moving mass per 10 mm stroke	9	16	25	25	39	39	63
<b>DSBC...-E1/-E2/-E3</b>							
Product weight with 0 mm stroke							
DSBC...-E1	505	780	1312	1862	3018	4023	–
DSBC...-E2	485	760	1251	1801	2839	3844	–
DSBC...-E3	485	760	1251	1801	2839	3844	–
Additional weight per 10 mm stroke	27	37	56	62	92	101	–
Moving mass with 0 mm stroke	110	205	365	430	810	1000	–
Moving mass per 10 mm stroke	9	16	25	25	39	39	–
<b>DSBC...-T</b>							
Product weight with 0 mm stroke	581	924	1523	2103	3243	4353	7450
Additional weight per 10 mm stroke	34	50	81	86	133	141	214
Moving mass with 0 mm stroke	181	339	613	684	1292	1516	3084
Moving mass per 10 mm stroke	18	32	50	50	78	78	126

## Data sheet

ATEX <sup>1)</sup>	
ATEX category for gas	II 2G
Type of ignition protection for gas	Ex h IIC T4 Gb
ATEX category for dust	II 2D
Type of ignition protection for dust	Ex h IIIC T120°C Db
Explosion-proof ambient temperature	-20°C ≤ Ta ≤ +60°C
CE marking (see declaration of conformity)	To EU Explosion Protection Directive (ATEX)
UKCA marking (see declaration of conformity)	To UK EX instructions
Explosion protection certification outside the EU	EPL Gb (GB)
	EPL Db (GB)

1) Note the ATEX certification of the accessories.

Forces [N] and impact energy [J]							
Piston diameter	32	40	50	63	80	100	125
Theoretical force at 6 bar, advancing	483	754	1178	1870	3016	4712	7363
Theoretical force at 6 bar, retracting	415	633	990	1682	2721	4418	6881
Max. impact energy in the end positions							
DSBC...	0.4 <sup>1)</sup>	0.7	1.0	1.3	1.8	2.5	3.3
DSBC...-L/-U/-T1/-T3/-T4	0.2 <sup>1)</sup>	0.35	0.5	0.65	0.9	1.25	1.65
DSBC...-L1	0.1	0.2	0.3	0.4	0.9	1.25	1.65

1) The max. impact energy in combination with the trunnion flange kit DAMT is 0.1 J.

Permissible impact velocity: 
$$V = \sqrt{\frac{2 \times E}{m_1 + m_2}}$$

Maximum permissible mass: 
$$m_2 = \frac{2 \times E}{v^2} - m_1$$

V Permissible impact velocity  
 E Max. impact energy  
 m1 Moving mass (drive)  
 m2 Moving payload

### Max. transverse load Fq as a function of stroke length l

Horizontal installation

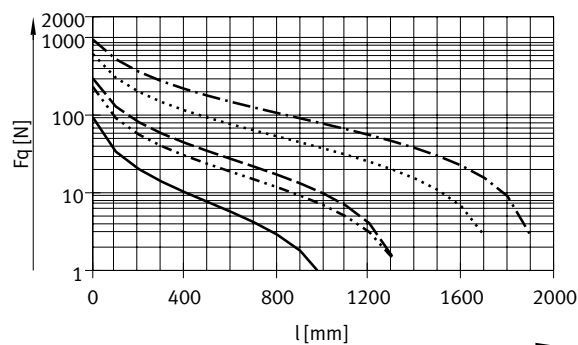

Vertical installation

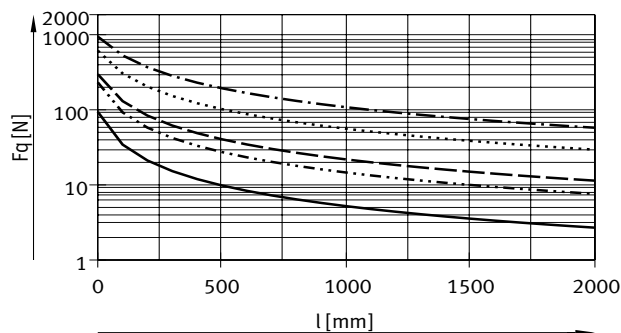

- ∅ 32
- · - · - ∅ 40
- - - ∅ 50/63
- · · · · ∅ 80/100
- · - · - ∅ 125

#### Note

No transverse forces are permitted in combination with feature DSBC...-L1.

Permissible torsional backlash with variant Q – With protection against rotation							
Piston diameter	32	40	50	63	80	100	
Torsional backlash [°]	±0.65	±0.6	±0.45	±0.45	±0.45	±0.45	

Data sheet

Max. transverse force  $F_q$  as a function of stroke length  $l$  and lever arm  $s$

Q – With protection against rotation

$\varnothing 32$

Max. torque = 800 Nmm/max. stroke = 300 mm

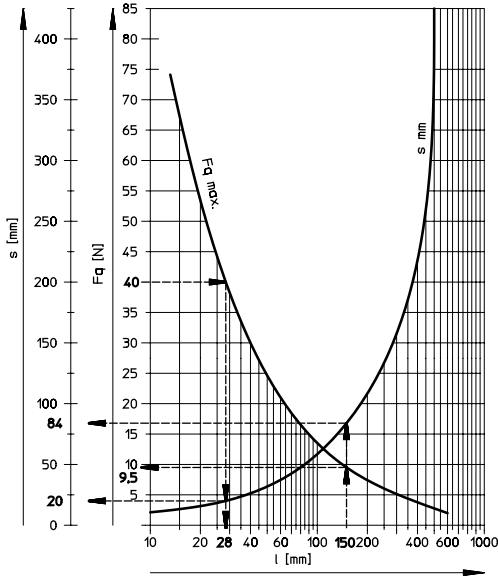

$\varnothing 40$

Max. torque = 1100 Nmm/max. stroke = 400 mm

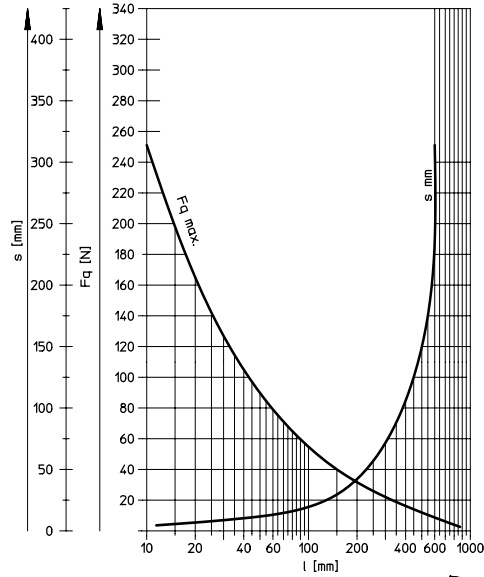

$\varnothing 50/63$

Max. torque = 1500 Nmm/max. stroke = 500 mm

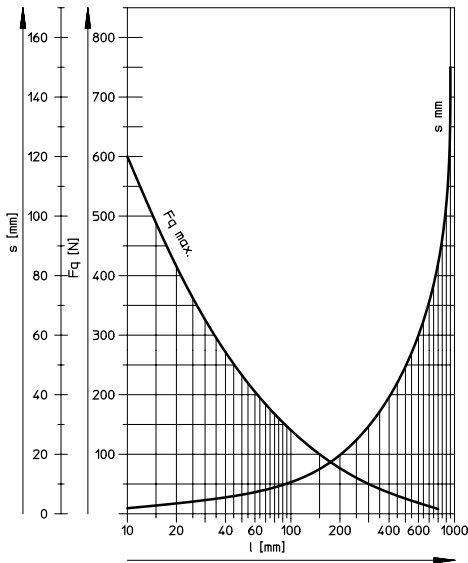

$\varnothing 80/100$

Max. torque = 3000 Nmm/max. stroke = 600 mm

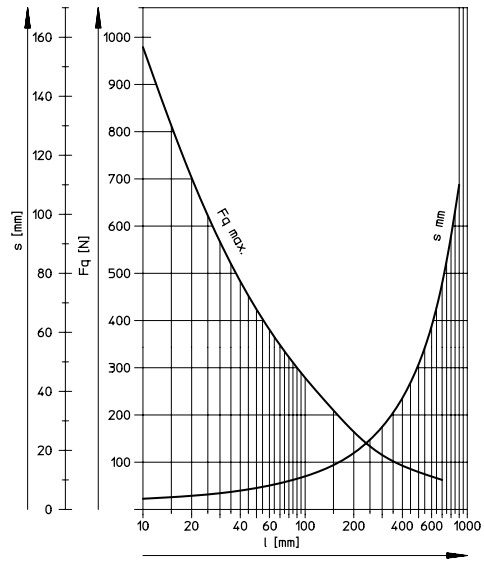

Examples for piston diameter 32 mm

Example 1:

Stroke length  $l$  = 150 mm

Result: Permissible

Transverse force  $F_q$  = 9.5 N

Lever arm  $s$  = 84 mm

Example 2:

Transverse force  $F_q$  = 40 N

Result: Permissible

Stroke length  $l$  = 28 mm

Lever arm  $s$  = 20 mm

Example 3:

Stroke length  $l$  = 150 mm

Lever arm  $s$  = 100 mm

$$F_q = \frac{M}{s} = \frac{800 \text{ Nmm}}{100 \text{ mm}}$$

$M$  = Max. torque

$s$  = Lever arm

Result: Permissible

$$F_q = 8 \text{ N} < F_{q_{\text{max}}} = 9.5 \text{ N}$$

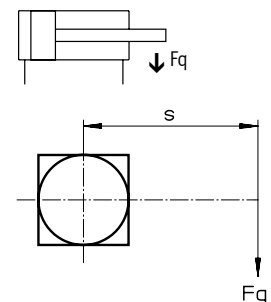

## Data sheet

### Materials

#### Sectional view – Basic design

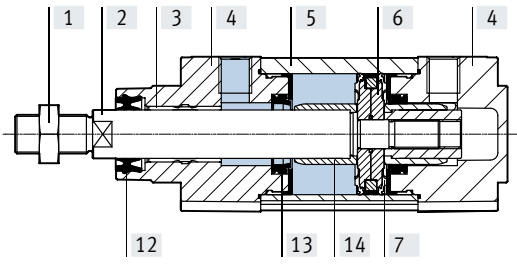

#### With clamping unit

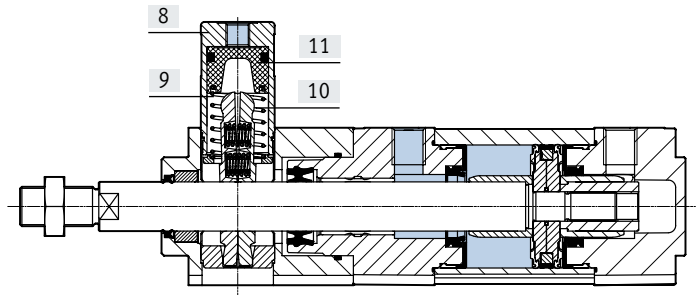

#### With end-position locking

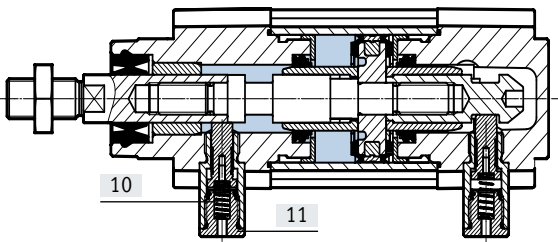



## Data sheet

Standards-based cylinder	
[1] Nut	Galvanised steel
[2] Piston rod	
DSBC...	High-alloy steel
DSBC...-R3	High-alloy stainless steel
DSBC...-A2/-A6	Hard-chrome plated tempered steel
[3] Bearing	
DSBC...	POM
DSBC...-E1/-E2/-E3/-SL/-EX4/-A2/-Q	Bronze
DSBC...-L/-U/-T1/-T4	Metal polymer compound
[4] Cover	Coated die-cast aluminium
[5] Profile barrel	Anodised wrought aluminium alloy
[6] Piston	Anodised wrought aluminium alloy
[7] Piston seal	
DSBC...	TPE-U(PU)
DSBC...-L/-U/-T1/-T4	FPM
DSBC...-T3	TPE-U(PU)
DSBC...-L1	HNBR
[8] Housing, clamping unit	Anodised wrought aluminium alloy
[9] Clamping jaws, clamping unit	Brass
[10] Spring	
DSBC...-C	Spring steel
DSBC...-E1/E2/E3	High-alloy stainless steel
[11] Piston, clamping unit/end-position locking	
DSBC...-C	POM
DSBC...-E1/E2/E3	Hardened steel
[12] Piston rod wiper seal	
DSBC...	PUR
DSBC...-L/-U	FPM
DSBC...-L1	HNBR
DSBC...-T1/-T4/-A1	FPM
DSBC...-T3	PUR (suitable for low temperatures)
DSBC...-A3	UHMW-PE
[13] Buffer seal	
DSBC...	PUR
DSBC...-U	FPM
DSBC...-T1/-T4	FPM
DSBC...-T3	PUR (suitable for low temperatures)
[14] Buffer sleeve	
DSBC...	POM
DSBC...-L/-U	Aluminium
DSBC...-T1/-T3/-T4	Aluminium
- Piston rod scraper	
DSBC...-A6	CuZn
DSBC...-T3/-A2	PTFE reinforced
- Housing, end-position locking	Anodised wrought aluminium alloy
- Flange screw	Galvanised steel
- Note on materials	
DSBC...	RoHS-compliant
DSBC...-L/U/-T3/-T4/-A3	Contains paint-wetting impairment substances
DSBC...-F1A	Metals with copper, zinc or nickel as the main constituent are excluded from use. Exceptions are nickel in steels, chemically nickel-plated surfaces, printed circuit boards, cables, electrical plug connectors and coils.

## Data sheet

## Technical data DSBC-...-E1/-E2/-E3 – With end-position locking

- In order to ensure that the lock is completely released prior to starting the drive movement, end-position locking should only be used in conjunction with double-acting cylinders with exhaust-air flow control.
- The end-position locking may only be released if the forces at the piston have reached equilibrium. Otherwise, a sudden movement of the piston rod could cause accidents. Blocking off the air supply at both ends (e.g. with a 5/3-way valve) does not provide any safety.
- The piston rod can be locked in any stroke position once the drive is brought mechanically into its end position.
- An excessive end-position cushioning setting (more than 50% closed) can result in the locking bolt not engaging reliably, resulting in premature wear.
- The exhaust hole must not be closed.

Piston diameter		32	40	50	63	80	100
Clamping type		Positive interlocking with stop cylinder					
		Release through compressed air					
Static holding force	[N]	500	500	2000	2000	5000	5000
Max. axial backlash with end position locked	[mm]	1.3	1.3	1.3	1.5	1.5	1.5
Min. unlocking pressure	[MPa]	≤ 0.25		≤ 0.15			
	[bar]	≤ 2.5		≤ 1.5			
Max. locking pressure	[MPa]	≥ 0.05					
	[bar]	≥ 0.5					

## Sizing example

When sizing pneumatic cylinders it is recommended as a basic principle that only 50% of the indicated theoretical forces (see above) be used.

**Given:**

Mounting position = vertical

Workpiece load = 44 kg

$$F = m \times g = 44 \text{ kg} \times 9.81 \text{ m/s}^2 \\ = 431.6 \text{ N}$$

**To be calculated:**

Suitable piston diameter

**Example with 32 mm piston diameter:**

Theoretical force at 6 bar, advancing = 483 N

50% of the theoretical force = 241.5 N

Static holding force with 32 mm piston diameter = 500 N

The static holding force of end-position locking is within the permissible range (max. 500 N) for a workpiece load of 44 kg (431.6 N); however the cylinder would be at 89% capacity.

**Result:**

A cylinder with a piston diameter of 40 mm is therefore recommended for this application.

## Data sheet

## Technical data DSBC-...C – With clamping unit

- The specified holding force refers to a static load. If this value is exceeded, the piston rod may slip. Dynamic forces occurring during operation must not exceed the static holding force. The clamping unit is not backlash-free in the clamped condition if varying loads are applied to the piston rod.
- The clamping unit may only be released if the forces at the piston have reached equilibrium. Otherwise, a sudden movement of the piston rod could cause accidents. Blocking off the air supply at both ends (e.g. with a 5/3-way valve) does not provide any safety.

Piston diameter		32	40	50	63	80	100	125
Type of clamping with active direction		At both ends						
		Clamping through spring force						
		Release through compressed air						
Static holding force	[N]	600	1000	1400	2000	5000	5000	7500
Max. axial play under load	[mm]	0.5	0.5	0.8	0.8	0.8	0.8	1.8
Min. release pressure	[MPa]	0.3						
	[bar]	3						

Data sheet

Dimensions

Download CAD data → [www.festo.com](http://www.festo.com)

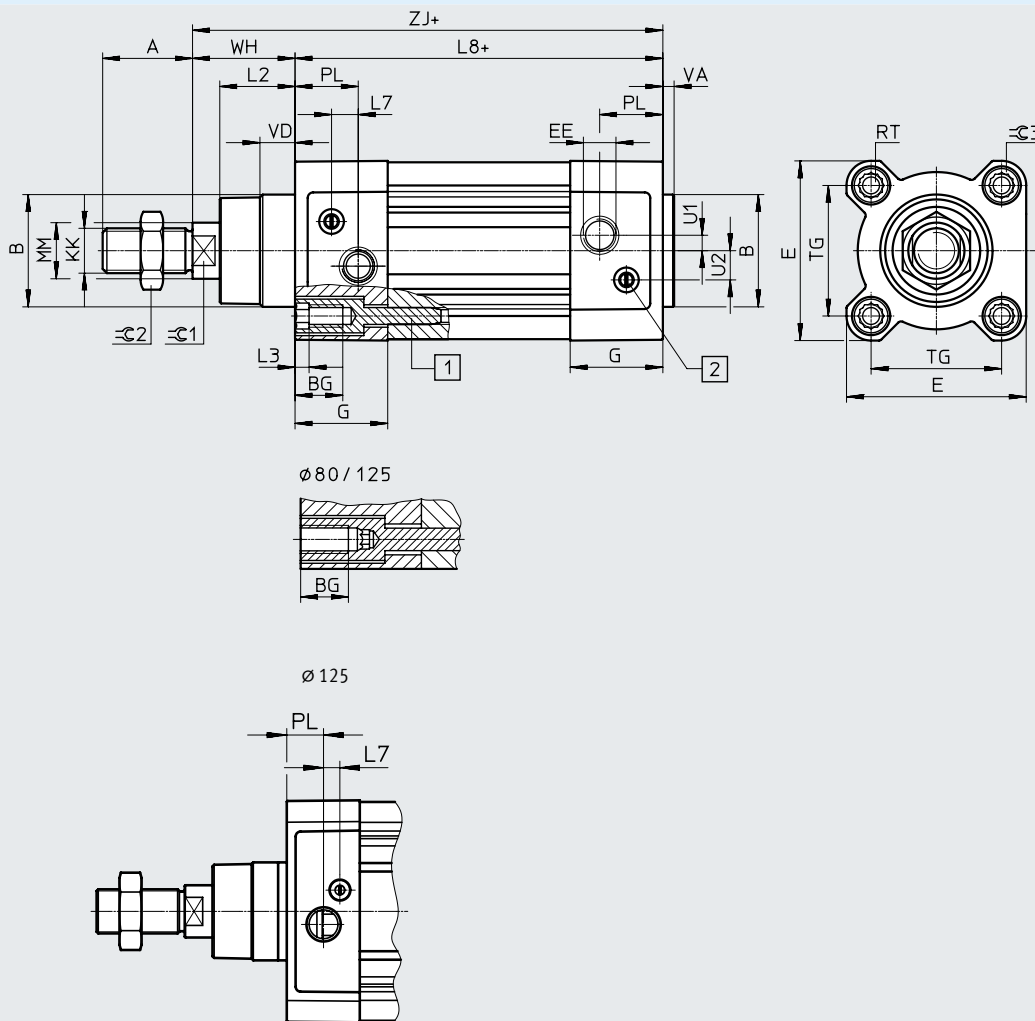

Variant

T – Through piston rod

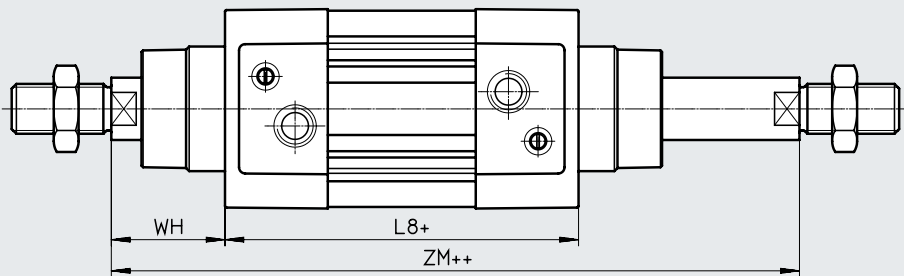

+ = plus stroke length  
 ++ = plus 2x stroke length

## Data sheet

∅ [mm]	A -0.5	B ∅ d11	BG min.	E +0.5	EE	G -0.2	U2 ±0.1	U1 ±0.1	KK
32	22	30	16	45	G1/8	28	5.7	5.25	M10x1.25
40	24	35	16	54	G1/4	33	8	4	M12x1.25
50	32	40	16	64	G1/4	33	10.4	5.5	M16x1.5
63	32	45	16	75	G3/8	40.5	12.75	6.25	M16x1.5
80	40	45	17	93	G3/8	43	12.5	8	M20x1.5
100	40	55	17	110	G1/2	48	13.5	10	M20x1.5
125	54	60	20	136	G1/2	44.7	13	8	M27x2

∅ [mm]	L2	L3 max.	L7	L8 ±0.4	MM ∅	PL ±0.1	RT	TG ±0.3
32	18 <sub>-0.2</sub>	5	6.5	94	12	19.5	M6	32.5
40	21.3 <sub>-0.2</sub>	5	7.5	105	16	22.5	M6	38
50	26.8 <sub>-0.2</sub>	5	9.5	106	20	22.5	M8	46.5
63	27 <sub>-0.2</sub>	5	9	121	20	27.5	M8	56.5
80	34.2 <sub>-0.2</sub>	–	11	128	25	30	M10	72
100	38 <sub>-0.2</sub>	–	7.5	138	25	31.5	M10	89
125	45.5 <sub>-0.3</sub>	–	10	160	32	22.5	M12	110

∅ [mm]	VA	VD +0.5	WH +2.2	ZJ +1.8	ZM +1	≙G1	≙G2	≙G3
32	4 <sub>-0.2</sub>	10	25	119.1	146.1	10	16	6
40	4 <sub>-0.2</sub>	10.5	28.7	133.9	164.8	13	18	6
50	4 <sub>-0.2</sub>	11.5	35.6	141.8	179.8	17	24	8
63	4 <sub>-0.2</sub>	15	35.9	157.1	195.4	17	24	8
80	4 <sub>-0.2</sub>	15.7	45.4	173.6	221	22	30	6
100	4 <sub>-0.2</sub>	19.2	49.3	187.5	238.8	22	30	6
125	6 <sub>-0.3</sub>	20.5	64.1	225	290	27	41	8

## Data sheet

### Dimensions – Variants

Download CAD data → [www.festo.com](http://www.festo.com)

Q – With protection against rotation

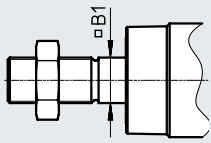

- - **Note**

In combination with variant T, the piston rod is protected against rotation at one end.

F – Female thread

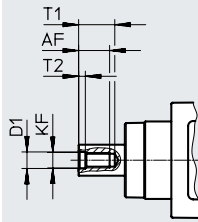

- - **Note**

In combination with variant T, the piston rod has female threads at both ends.

...E – Extended piston rod

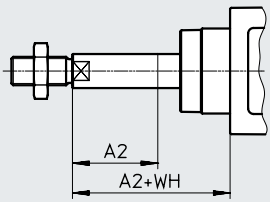

- - **Note**

Piston rod thread is extended at one end in combination with the variant T. Piston rod extension only at the square piston rod in combination with the variants T and Q

...L – Extended piston rod thread

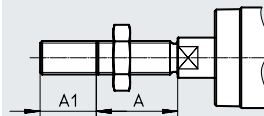

- - **Note**

Piston rod thread is extended at both ends in combination with variant T.

D3 – Sensor slot on 3 sides

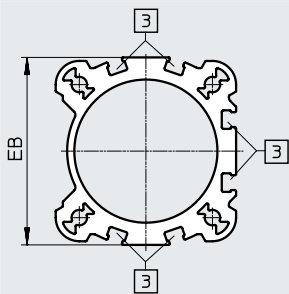

[3] Sensor slot for proximity switch

## Data sheet

∅ [mm]	A	A1		A2		AF min.
		min.	max.	min.	max.	
32	22	1	35	1	500	12
40	24	1	35	1	500	12
50	32	1	70	1	500	16
63	32	1	70	1	500	16
80	40	1	70	1	500	20
100	40	1	70	1	500	20
125	54	1	70	1	500	32

∅ [mm]	B1	D1	EB	KF	T1	T2	WH +2.2
					max.		
32	10	6.4	47 <sub>-0.3</sub>	M6	16	2.6	25
40	12	8.4	54.8 <sup>+0.3</sup>	M8	16	3.3	28.7
50	16	10.5	65.5 <sup>+0.3/-0.05</sup>	M10	21	4.7	35.6
63	16	10.5	76 <sub>-1</sub>	M10	21	4.7	35.9
80	20	13	92 <sub>-0.5</sub>	M12	26.5	6.1	45.4
100	20	13	109 <sub>-0.5</sub>	M12	26.5	6.1	49.3
125	–	17	132 <sup>+0.8</sup>	M16	40	8	64.1

## Data sheet

### Dimensions – Variants

Download CAD data → [www.festo.com](http://www.festo.com)

C – Clamping unit

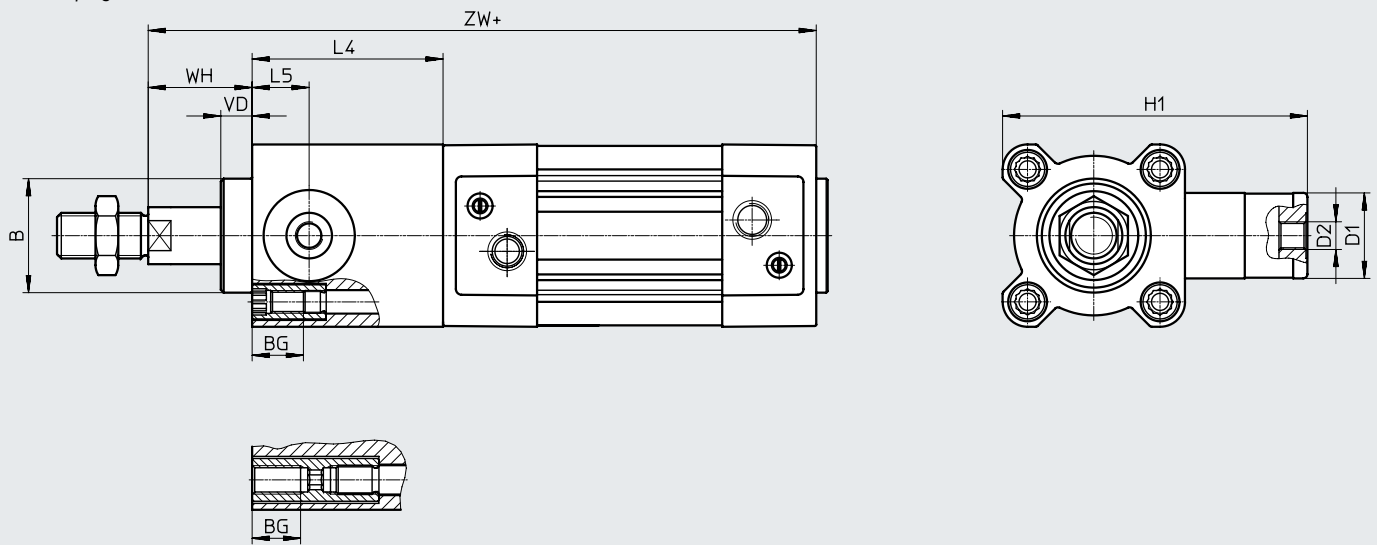

-  - **Note**

The clamping unit can only be selected with variant T in combination with variant Q.

The clamping unit is mounted on the round piston rod end in combination with variants T and Q.

+ = plus stroke length

∅ [mm]	B ∅ d11	BG	D1	D2	H1	L4 ±0.2	L5	VD	WH	ZW ±1.8
32	30	16	20	M5	67	45	14	11.5	26	164.1
40	35	16	24	G1/8	88	53	16	11.5	30	186.9
50	40	16	30	G1/8	107	67	20	11	37	208.8
63	45	16	38	G1/8	123	76	24	11	37	233.1
80	45	17	48	G1/8	165	95	31.5	12.5	46	268.6
100	55	17	48	G1/8	174	98	31	12	51	285.7
125	60	20	65	G1/8	208	125	42	27.5	65	349.3



## Data sheet

## Dimensions – Variants

Download CAD data → [www.festo.com](http://www.festo.com)

## E1/E2/E3 – End-position locking

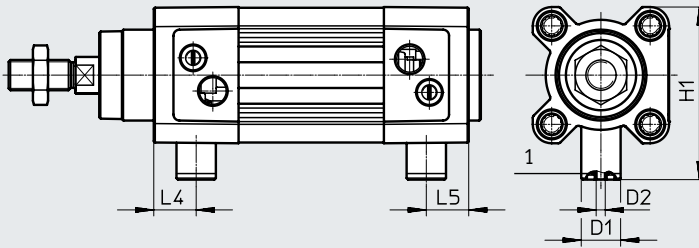

- [1] - **Note**

- [1] The connection is used for the manual interlock and/or ducted exhaust air. It must not be sealed or pressurised.

## E1 - End-position locking at both ends

$\varnothing$ [mm]	D1 $\varnothing$	D2	H1	L4	L5
32	13	M3	57.5	14	14
40	13	M3	64	17	17
50	20	M5	78.5	18	18
63	20	M5	84.5	25	25
80	30	M5	105	22	22
100	30	M5	113.5	25.5	25.5

## E2 – End-position locking with advanced piston rod

$\varnothing$ [mm]	D1 $\varnothing$	D2	H1	L4
32	13	M3	57.5	14
40	13	M3	64	17
50	20	M5	78.5	18
63	20	M5	84.5	25
80	30	M5	105	22
100	30	M5	113.5	25.5

## E3 – End-position locking with retracted piston rod

$\varnothing$ [mm]	D1 $\varnothing$	D2	H1	L5
32	13	M3	57.5	14
40	13	M3	64	17
50	20	M5	78.5	18
63	20	M5	84.5	25
80	30	M5	105	22
100	30	M5	113.5	25.5

Data sheet

Dimensions – Variants

Download CAD data → [www.festo.com](http://www.festo.com)

P2 – Bellows on the bearing cap

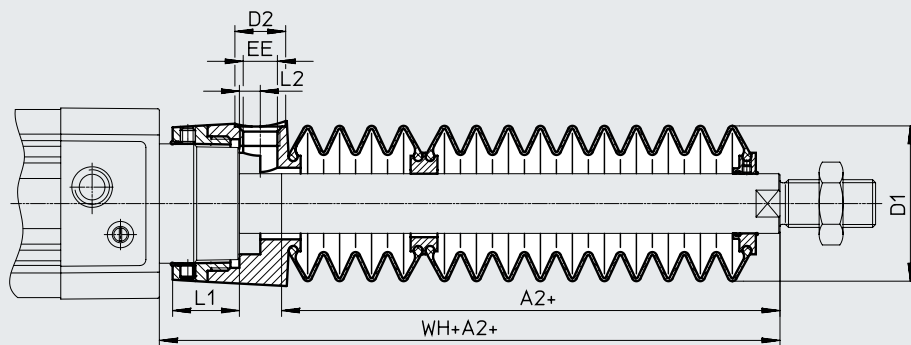

+ = plus stroke length

∅ Stroke [mm]	32							40						
	A2 <sup>1)</sup>	D1 max.	D2	EE	L1	L2	WH+A2	A2 <sup>1)</sup>	D1 max.	D2	EE	L1	L2	WH+A2
10 ... 50	29	38	14	G1/8	12.9	5.4	55	28	46	14	G1/8	16.3	5.4	56.7
51 ... 125	47						73	43						71.7
126 ... 175	61						87	56						84.7
176 ... 250	80						106	72						100.7
251 ... 300	96						122	86						114.7
301 ... 350	112						138	100						128.7
351 ... 375	114						140	101						129.7
376 ... 425	130						156	115						143.7
426 ... 475	145						171	130						158.7
476 ... 500	147	173	131	159.7										

∅ Stroke [mm]	50							63						
	A2 <sup>1)</sup>	D1 max.	D2	EE	L1	L2	WH+A2	A2 <sup>1)</sup>	D1 max.	D2	EE	L1	L2	WH+A2
10 ... 50	28	57	17	G1/4	22.35	7	63.6	28	57	17	G1/4	22.4	7	63.9
51 ... 125	46						81.6	46						81.9
126 ... 175	56						91.6	56						91.9
176 ... 250	73						108.6	73						108.9
251 ... 300	86						121.6	86						121.9
301 ... 350	97						132.6	97						132.9
351 ... 375	105						140.6	105						140.9
376 ... 425	116						151.6	116						151.9
426 ... 475	126						161.6	126						161.9
476 ... 500	134	169.6	134	169.9										

1) The dimension corresponds to the E value (piston rod extension) of the drive

## Data sheet

∅ Stroke [mm]	80							100						
	A2 <sup>1)</sup>	D1 max.	D2	EE	L1	L2	WH+A2	A2 <sup>1)</sup>	D1 max.	D2	EE	L1	L2	WH+A2
10 ... 50	25	93	17	G1/4	28	4	70.4	25	93	17	G1/4	28	4	74.3
51 ... 125	37						82.4	37						86.3
126 ... 175	49						94.4	49						98.3
176 ... 250	62						107.4	62						111.3
251 ... 300	74						119.4	74						123.3
301 ... 350	86						131.4	86						135.3
351 ... 375	87						132.4	87						136.3
376 ... 425	98						143.4	98						147.3
426 ... 475	110						155.4	110						159.3
476 ... 500	111						156.4	111						160.3

1) The dimension corresponds to the E value (piston rod extension) of the drive

## Data sheet

Ordering data				With PPS cushioning	
Piston diameter [mm]	Stroke [mm]	With PPV cushioning		Part no.	Type
		Part no.	Type		
32	20	★ 2123069	DSBC-32-20-PPVA-N3	★ 2123085	DSBC-32-20-PPSA-N3
	25	★ 1376422	DSBC-32-25-PPVA-N3	★ 1376467	DSBC-32-25-PPSA-N3
	30	★ 2123070	DSBC-32-30-PPVA-N3	★ 2123086	DSBC-32-30-PPSA-N3
	40	★ 1376423	DSBC-32-40-PPVA-N3	★ 1376468	DSBC-32-40-PPSA-N3
	50	★ 1376424	DSBC-32-50-PPVA-N3	★ 1376469	DSBC-32-50-PPSA-N3
	60	★ 2123071	DSBC-32-60-PPVA-N3	★ 2123087	DSBC-32-60-PPSA-N3
	70	★ 2123072	DSBC-32-70-PPVA-N3	★ 2123088	DSBC-32-70-PPSA-N3
	80	★ 1376425	DSBC-32-80-PPVA-N3	★ 1376470	DSBC-32-80-PPSA-N3
	100	★ 1376426	DSBC-32-100-PPVA-N3	★ 1376471	DSBC-32-100-PPSA-N3
	125	★ 1376427	DSBC-32-125-PPVA-N3	★ 1376472	DSBC-32-125-PPSA-N3
	150	★ 2123073	DSBC-32-150-PPVA-N3	★ 2123089	DSBC-32-150-PPSA-N3
	160	★ 1376428	DSBC-32-160-PPVA-N3	★ 1376473	DSBC-32-160-PPSA-N3
	200	★ 1376429	DSBC-32-200-PPVA-N3	★ 1376474	DSBC-32-200-PPSA-N3
	250	★ 1376430	DSBC-32-250-PPVA-N3	★ 1376475	DSBC-32-250-PPSA-N3
	300	★ 2123074	DSBC-32-300-PPVA-N3	★ 2123090	DSBC-32-300-PPSA-N3
	320	★ 1376431	DSBC-32-320-PPVA-N3	★ 1376476	DSBC-32-320-PPSA-N3
	400	★ 1376432	DSBC-32-400-PPVA-N3	★ 1376477	DSBC-32-400-PPSA-N3
500	★ 1376433	DSBC-32-500-PPVA-N3	★ 1376478	DSBC-32-500-PPSA-N3	
40	20	★ 2123166	DSBC-40-20-PPVA-N3	★ 2123780	DSBC-40-20-PPSA-N3
	25	★ 1376656	DSBC-40-25-PPVA-N3	★ 1376903	DSBC-40-25-PPSA-N3
	30	★ 2123167	DSBC-40-30-PPVA-N3	★ 2123781	DSBC-40-30-PPSA-N3
	40	★ 1376657	DSBC-40-40-PPVA-N3	★ 1376904	DSBC-40-40-PPSA-N3
	50	★ 1376658	DSBC-40-50-PPVA-N3	★ 1376905	DSBC-40-50-PPSA-N3
	60	★ 2123224	DSBC-40-60-PPVA-N3	★ 2123782	DSBC-40-60-PPSA-N3
	70	★ 2123225	DSBC-40-70-PPVA-N3	★ 2123783	DSBC-40-70-PPSA-N3
	80	★ 1376659	DSBC-40-80-PPVA-N3	★ 1376906	DSBC-40-80-PPSA-N3
	100	★ 1376660	DSBC-40-100-PPVA-N3	★ 1376907	DSBC-40-100-PPSA-N3
	125	★ 1376661	DSBC-40-125-PPVA-N3	★ 1376908	DSBC-40-125-PPSA-N3
	150	★ 2123226	DSBC-40-150-PPVA-N3	★ 2123784	DSBC-40-150-PPSA-N3
	160	★ 1376662	DSBC-40-160-PPVA-N3	★ 1376909	DSBC-40-160-PPSA-N3
	200	★ 1376663	DSBC-40-200-PPVA-N3	★ 1376910	DSBC-40-200-PPSA-N3
	250	★ 1376664	DSBC-40-250-PPVA-N3	★ 1376911	DSBC-40-250-PPSA-N3
	300	★ 2123227	DSBC-40-300-PPVA-N3	★ 2123785	DSBC-40-300-PPSA-N3
	320	★ 1376665	DSBC-40-320-PPVA-N3	★ 1376912	DSBC-40-320-PPSA-N3
	400	★ 1376666	DSBC-40-400-PPVA-N3	★ 1376913	DSBC-40-400-PPSA-N3
500	★ 1376667	DSBC-40-500-PPVA-N3	★ 1376914	DSBC-40-500-PPSA-N3	

 Note

Other variants in the modular product system → page 32

## Data sheet

Ordering data					
Piston diameter [mm]	Stroke [mm]	With PPV cushioning		With PPS cushioning	
		Part no.	Type	Part no.	Type
50	20	★ 2098969	DSBC-50-20-PPVA-N3	★ 2102628	DSBC-50-20-PPSA-N3
	25	★ 1366948	DSBC-50-25-PPVA-N3	★ 1376301	DSBC-50-25-PPSA-N3
	30	★ 2098970	DSBC-50-30-PPVA-N3	★ 2102629	DSBC-50-30-PPSA-N3
	40	★ 1366949	DSBC-50-40-PPVA-N3	★ 1376304	DSBC-50-40-PPSA-N3
	50	★ 1366950	DSBC-50-50-PPVA-N3	★ 1376305	DSBC-50-50-PPSA-N3
	60	★ 2098972	DSBC-50-60-PPVA-N3	★ 2102630	DSBC-50-60-PPSA-N3
	70	★ 2098973	DSBC-50-70-PPVA-N3	★ 2102631	DSBC-50-70-PPSA-N3
	80	★ 1366951	DSBC-50-80-PPVA-N3	★ 1376306	DSBC-50-80-PPSA-N3
	100	★ 1366952	DSBC-50-100-PPVA-N3	★ 1376307	DSBC-50-100-PPSA-N3
	125	★ 1366953	DSBC-50-125-PPVA-N3	★ 1376308	DSBC-50-125-PPSA-N3
	150	★ 2098974	DSBC-50-150-PPVA-N3	★ 2102632	DSBC-50-150-PPSA-N3
	160	★ 1366954	DSBC-50-160-PPVA-N3	★ 1376309	DSBC-50-160-PPSA-N3
	200	★ 1366955	DSBC-50-200-PPVA-N3	★ 1376310	DSBC-50-200-PPSA-N3
	250	★ 1366956	DSBC-50-250-PPVA-N3	★ 1376311	DSBC-50-250-PPSA-N3
	300	★ 2098975	DSBC-50-300-PPVA-N3	★ 2102633	DSBC-50-300-PPSA-N3
	320	★ 1366957	DSBC-50-320-PPVA-N3	★ 1376312	DSBC-50-320-PPSA-N3
	400	★ 1366958	DSBC-50-400-PPVA-N3	★ 1376313	DSBC-50-400-PPSA-N3
500	★ 1366959	DSBC-50-500-PPVA-N3	★ 1376314	DSBC-50-500-PPSA-N3	
63	20	★ 2125490	DSBC-63-20-PPVA-N3	★ 2126684	DSBC-63-20-PPSA-N3
	25	★ 1383578	DSBC-63-25-PPVA-N3	★ 1383632	DSBC-63-25-PPSA-N3
	30	★ 2125491	DSBC-63-30-PPVA-N3	★ 2126685	DSBC-63-30-PPSA-N3
	40	★ 1383579	DSBC-63-40-PPVA-N3	★ 1383633	DSBC-63-40-PPSA-N3
	50	★ 1383580	DSBC-63-50-PPVA-N3	★ 1383634	DSBC-63-50-PPSA-N3
	60	★ 2125492	DSBC-63-60-PPVA-N3	★ 2126686	DSBC-63-60-PPSA-N3
	70	★ 2125493	DSBC-63-70-PPVA-N3	★ 2126687	DSBC-63-70-PPSA-N3
	80	★ 1383581	DSBC-63-80-PPVA-N3	★ 1383635	DSBC-63-80-PPSA-N3
	100	★ 1383582	DSBC-63-100-PPVA-N3	★ 1383636	DSBC-63-100-PPSA-N3
	125	★ 1383583	DSBC-63-125-PPVA-N3	★ 1383637	DSBC-63-125-PPSA-N3
	150	★ 2125494	DSBC-63-150-PPVA-N3	★ 2126688	DSBC-63-150-PPSA-N3
	160	★ 1383584	DSBC-63-160-PPVA-N3	★ 1383638	DSBC-63-160-PPSA-N3
	200	★ 1383585	DSBC-63-200-PPVA-N3	★ 1383639	DSBC-63-200-PPSA-N3
	250	★ 1383586	DSBC-63-250-PPVA-N3	★ 1383640	DSBC-63-250-PPSA-N3
	300	★ 2125495	DSBC-63-300-PPVA-N3	★ 2126689	DSBC-63-300-PPSA-N3
	320	★ 1383587	DSBC-63-320-PPVA-N3	★ 1383641	DSBC-63-320-PPSA-N3
	400	★ 1383588	DSBC-63-400-PPVA-N3	★ 1383642	DSBC-63-400-PPSA-N3
500	★ 1383589	DSBC-63-500-PPVA-N3	★ 1383643	DSBC-63-500-PPSA-N3	

 - Note

Other variants in the modular product system → page 32

## Data sheet

Ordering data					
Piston diameter [mm]	Stroke [mm]	With PPV cushioning		With PPS cushioning	
		Part no.	Type	Part no.	Type
80	20	★ 2126594	DSBC-80-20-PPVA-N3	★ 2126636	DSBC-80-20-PPSA-N3
	25	★ 1383333	DSBC-80-25-PPVA-N3	★ 1383366	DSBC-80-25-PPSA-N3
	30	★ 2126595	DSBC-80-30-PPVA-N3	★ 2126637	DSBC-80-30-PPSA-N3
	40	★ 1383334	DSBC-80-40-PPVA-N3	★ 1383367	DSBC-80-40-PPSA-N3
	50	★ 1383335	DSBC-80-50-PPVA-N3	★ 1383368	DSBC-80-50-PPSA-N3
	60	★ 2126597	DSBC-80-60-PPVA-N3	★ 2126638	DSBC-80-60-PPSA-N3
	70	★ 2126598	DSBC-80-70-PPVA-N3	★ 2126639	DSBC-80-70-PPSA-N3
	80	★ 1383336	DSBC-80-80-PPVA-N3	★ 1383369	DSBC-80-80-PPSA-N3
	100	★ 1383337	DSBC-80-100-PPVA-N3	★ 1383370	DSBC-80-100-PPSA-N3
	125	★ 1383338	DSBC-80-125-PPVA-N3	★ 1383371	DSBC-80-125-PPSA-N3
	150	★ 2126599	DSBC-80-150-PPVA-N3	★ 2126640	DSBC-80-150-PPSA-N3
	160	★ 1383339	DSBC-80-160-PPVA-N3	★ 1383372	DSBC-80-160-PPSA-N3
	200	★ 1383340	DSBC-80-200-PPVA-N3	★ 1383373	DSBC-80-200-PPSA-N3
	250	★ 1383341	DSBC-80-250-PPVA-N3	★ 1383374	DSBC-80-250-PPSA-N3
	300	★ 2126600	DSBC-80-300-PPVA-N3	★ 2126641	DSBC-80-300-PPSA-N3
	320	★ 1383342	DSBC-80-320-PPVA-N3	★ 1383375	DSBC-80-320-PPSA-N3
	400	★ 1383343	DSBC-80-400-PPVA-N3	★ 1383376	DSBC-80-400-PPSA-N3
500	★ 1383344	DSBC-80-500-PPVA-N3	★ 1383377	DSBC-80-500-PPSA-N3	

 - Note

Other variants in the modular product system → page 32

## Data sheet

Ordering data					
Piston diameter [mm]	Stroke [mm]	With PPV cushioning		With PPS cushioning	
		Part no.	Type	Part no.	Type
32	1 ... 2800	1463254	DSBC-32-...-PPVA-N3	1463252	DSBC-32-...-PPSA-N3
40	1 ... 2800	1462834	DSBC-40-...-PPVA-N3	1462835	DSBC-40-...-PPSA-N3
50	1 ... 2800	1463766	DSBC-50-...-PPVA-N3	1463768	DSBC-50-...-PPSA-N3
63	1 ... 2800	1463483	DSBC-63-...-PPVA-N3	1463481	DSBC-63-...-PPSA-N3
80	1 ... 2800	1463504	DSBC-80-...-PPVA-N3	1463500	DSBC-80-...-PPSA-N3
100	25	1384804	DSBC-100-25-PPVA-N3	1384890	DSBC-100-25-PPSA-N3
	40	1384805	DSBC-100-40-PPVA-N3	1384891	DSBC-100-40-PPSA-N3
	50	1384806	DSBC-100-50-PPVA-N3	1384892	DSBC-100-50-PPSA-N3
	80	1384807	DSBC-100-80-PPVA-N3	1384893	DSBC-100-80-PPSA-N3
	100	1384808	DSBC-100-100-PPVA-N3	1384894	DSBC-100-100-PPSA-N3
	125	1384809	DSBC-100-125-PPVA-N3	1384895	DSBC-100-125-PPSA-N3
	160	1384810	DSBC-100-160-PPVA-N3	1384896	DSBC-100-160-PPSA-N3
	200	1384811	DSBC-100-200-PPVA-N3	1384897	DSBC-100-200-PPSA-N3
	250	1384812	DSBC-100-250-PPVA-N3	1384898	DSBC-100-250-PPSA-N3
	320	1384813	DSBC-100-320-PPVA-N3	1384899	DSBC-100-320-PPSA-N3
	400	1384814	DSBC-100-400-PPVA-N3	1384900	DSBC-100-400-PPSA-N3
500	1384815	DSBC-100-500-PPVA-N3	1384901	DSBC-100-500-PPSA-N3	
1 ... 2800	1463598	DSBC-100-...-PPVA-N3	1463558	DSBC-100-...-PPSA-N3	
125	25	1804956	DSBC-125-25-PPVA-N3	1804661	DSBC-125-25-PPSA-N3
	40	1804957	DSBC-125-40-PPVA-N3	1804662	DSBC-125-40-PPSA-N3
	50	1804958	DSBC-125-50-PPVA-N3	1804663	DSBC-125-50-PPSA-N3
	80	1804959	DSBC-125-80-PPVA-N3	1804664	DSBC-125-80-PPSA-N3
	100	1804960	DSBC-125-100-PPVA-N3	1804665	DSBC-125-100-PPSA-N3
	125	1804961	DSBC-125-125-PPVA-N3	1804666	DSBC-125-125-PPSA-N3
	160	1804962	DSBC-125-160-PPVA-N3	1804667	DSBC-125-160-PPSA-N3
	200	1804963	DSBC-125-200-PPVA-N3	1804668	DSBC-125-200-PPSA-N3
	250	1804964	DSBC-125-250-PPVA-N3	1804669	DSBC-125-250-PPSA-N3
	320	1804965	DSBC-125-320-PPVA-N3	1804671	DSBC-125-320-PPSA-N3
	400	1804966	DSBC-125-400-PPVA-N3	1804672	DSBC-125-400-PPSA-N3
	500	1804967	DSBC-125-500-PPVA-N3	1804673	DSBC-125-500-PPSA-N3
	1 ... 2800	1755348	DSBC-125-...-PPVA-N3	1755619	DSBC-125-...-PPSA-N3

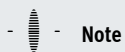
**Note**

Other variants in the modular product system → page 32

## Ordering data – Modular product system

Ordering table											
Size	32	40	50	63	80	100	125	Conditions	Code	Enter code	
Module no.	1463250	1461995	1463770	1463475	1463495	1463520	1722457				
Function	Standards-based cylinder, double-acting, based on ISO 15552								DSBC	DSBC	
Protection against rotation	None								★		
	With protection against rotation						-	[1]	★ -Q		
Running characteristics	Standard								★		
	Low friction						-	[2]	L		
	Constant, slow movement								[2]	U	
	Low friction for balancer applications								[3]	L1	
Piston diameter [mm]	32	40	50	63	80	100	125		★ -...		
Stroke [mm]	1 ... 2800								★ -...		
Piston rod type	At one end								★		
	Through piston rod								★ -T		
Piston rod thread type	Male thread								★		
	Female thread							[4]	★ F		
Profile type	Sensor slot on 1 side								★		
	Sensor slot on 3 sides								★ D3		
Cushioning	Elastic cushioning rings/plates at both ends							[5]	-P		
	Pneumatic cushioning, self-adjusting at both ends							[6]	★ -PPS		
	Pneumatic cushioning, adjustable at both ends								★ -PPV		
Position sensing	Via proximity switch								★ A	A	

[1] **Q** Not with L, U, L1, N3, T3, T4, P2, A1, A2, A3, A6  
Only up to a stroke of 1500 mm

[2] **L, U** Not with T, R3, T1, T3, T4, P2, A1, A2, A3, A6, EX4

[3] **L1** Not with T, PPV, R3, T1, T3, T4, P2, A1, A2, A3, A6, EX4

[4] **F** Not with ...L

[5] **P** Not with A1

[6] **PPS** Not with T1, T3, T4, A1

 - **Note**

If feature L is used in combination with transverse loads or strokes of above 500 mm, suitable measures must be taken to support the piston rod. The operating pressure (→ page 12) is applicable for strokes up to 500 mm.

 - **Note**

If feature L1 is used in combination with strokes of above 500 mm, suitable measures must be taken to support the piston rod. The operating pressure (→ page 12) is applicable for strokes up to 500 mm.



## Ordering data – Modular product system

Ordering table										
Size	32	40	50	63	80	100	125	Conditions	Code	Enter code
Standard	Based on ISO 15552								★	
	Corresponds to ISO 15552								★ -N3	
Corrosion protection	Standard								★	
	High corrosion protection							[7]	★ R3	
Temperature range	Standard								★	
	[°C]	Heat-resistant seals up to max. 120						[8]	★ T1	
	[°C]	-40 ... +80						[8]	T3	
	[°C]	0 ... +150						[8]	T4	
Protection against particles	Standard								★	
	Bellows on bearing cap						-	[9]	P2	
Scraper variant	None								★	
	Increased chemical resistance								A1	
	Hard scraper								A2	
	For unlubricated operation								A3	
	Metal scraper								A6	
EU certification	None								★	
	[mm]	II 2GD						[10]	EX4	
Piston rod extension	None									
	[mm]	1 ... 500						[11]	★ -...E	
Piston rod thread extension	None									
	[mm]	1 ... 35		1 ... 70				[11]	-...L	

[7] **R3** Not with A2, A6

[8] **T1, T3, T4** Not with P2, A1, A2, A3, EX4

[9] **P2** Not with N3, A1, A2, A3, A6, EX4  
Only for strokes of 10 ... 500 mm

[10] **EX4** Not with T1, T3, T4, P2, A1, A3, A6

[11] **E, ...L** Only up to a stroke of 2000 mm

 - **Note**

The piston rod extension for the bellows is automatically taken into consideration when feature P2 is selected. This means that there is no need to specify a value for feature ...E.

 - **Note**

When selecting feature ...E in combination with feature P2, the extended part of the piston rod ...E is not covered by the bellows.

 - **Note**

When feature P2 is selected in combination with feature T (through piston rod), the bellows is mounted at one end only.

## Ordering data – Modular product system

Ordering table											
Size	32	40	50	63	80	100	125	Conditions	Code	Enter code	
Module no.	<b>1463250</b>	<b>1461995</b>	<b>1463770</b>	<b>1463475</b>	<b>1463495</b>	<b>1463520</b>	<b>1722457</b>				
Function	Standards-based cylinder, double-acting, based on ISO 15552								DSBC	DSBC	
Protection against rotation	None								★		
	With protection against rotation							–	[1]	★ -Q	
Piston diameter [mm]	32	40	50	63	80	100	125		★ -...		
Stroke [mm]	10 ... 2000									★ -...	
Clamping unit	Attached									★ -C	C
Piston rod type	At one end									★	
	Through piston rod									★ T	
Piston rod thread type	Male thread									★	
	Female thread								[2]	★ F	
Profile type	Sensor slot on 1 side									★	
	Sensor slot on 3 sides									★ D3	
Cushioning	Elastic cushioning rings/plates at both ends									-P	
	Pneumatic cushioning, self-adjusting at both ends									★ -PPS	
	Pneumatic cushioning, adjustable at both ends									★ -PPV	
Position sensing	Via proximity switch									★ A	A
Piston rod extension [mm]	None										
	1 ... 500									★ -...E	
Piston rod thread extension [mm]	None										
	1 ... 35			1 ... 70						-...L	

[1] **Q** Only available with T.  
Only up to a stroke of 1500 mm

[2] **F** Not with ...L

## Ordering data – Modular product system

Ordering table										
Size	32	40	50	63	80	100	Conditions	Code	Enter code	
Module no.	<b>1463250</b>	<b>1461995</b>	<b>1463770</b>	<b>1463475</b>	<b>1463495</b>	<b>1463520</b>				
Function	Standards-based cylinder, double-acting, based on ISO 15552								<b>DSBC</b>	DSBC
Piston diameter [mm]	32	40	50	63	80	100		-...		
Stroke [mm]	10 ... 2000								-...	
End-position locking	At both ends								<b>E1</b>	
	With advanced piston rod								<b>E2</b>	
	With retracted piston rod								<b>E3</b>	
Piston rod thread type	Male thread									
	Female thread						[1]		<b>F</b>	
Profile type	Sensor slot on 1 side									
	Sensor slot on 3 sides								<b>D3</b>	
Cushioning	Elastic cushioning rings/plates at both ends								<b>-P</b>	
	Pneumatic cushioning, adjustable at both ends								<b>-PPV</b>	
Position sensing	Via proximity switch								<b>A</b>	A
Piston rod extension [mm]	None									
	1 ... 500								<b>-...E</b>	
Piston rod thread extension [mm]	None									
	1 ... 35		1 ... 70						<b>-...L</b>	

1) **F** Not with ...L

## Ordering data – Modular product system

Ordering table											
Size	32	40	50	63	80	100	125	Conditions	Code	Enter code	
Module no.	8150687	8150688	8150689	8150690	8150691	8150692	8150693				
Function	Standards-based cylinder, double-acting, based on ISO 15552								<b>DSBC</b>	DSBC	
Piston diameter [mm]	32	40	50	63	80	100	125		-...		
Stroke [mm]	1 ... 2800									-...	
Piston rod type	At one end										
	Through piston rod									<b>T</b>	
Piston rod thread type	Male thread										
	Female thread							[1]		<b>F</b>	
Profile type	Sensor slot on 1 side										
	Sensor slot on 3 sides									<b>D3</b>	
Cushioning	Elastic cushioning rings/plates at both ends									<b>-P</b>	
	Pneumatic cushioning, self-adjusting at both ends									<b>-PPS</b>	
	Pneumatic cushioning, adjustable at both ends									<b>-PPV</b>	
Position sensing	Via proximity switch									<b>A</b>	A
Standard	Based on ISO 15552										
	Corresponds to ISO 15552									<b>-N3</b>	
Special material properties	Recommended for production facilities for the manufacture of lithium-ion batteries									<b>F1A</b>	F1A
Piston rod extension [mm]	None										
	1 ... 500							[1]		<b>-...E</b>	
Piston rod thread extension [mm]	None										
	1 ... 70							[1] [2]		<b>-...L</b>	

[1] **F, ...E, ...L** Not with N3[2] **-...L** Not with F

## Data sheet

## Ordering data – Versions for DSBC...D3 (sensor slots on 3 sides)

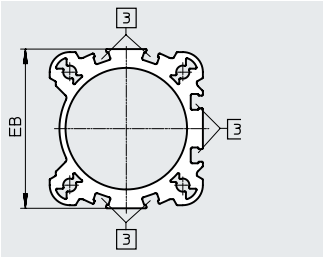

In this version, the piston position can be sensed on 3 sides of the drive.

[3] Sensor slot for proximity switch

Piston diameter [mm]	Stroke [mm]	With PPV cushioning		With PPS cushioning	
		Part no.	Type	Part no.	Type
32	20	3656511	DSBC-32-20-D3-PPVA-N3	3659374	DSBC-32-20-D3-PPSA-N3
	25	3656512	DSBC-32-25-D3-PPVA-N3	3659375	DSBC-32-25-D3-PPSA-N3
	30	3656513	DSBC-32-30-D3-PPVA-N3	3659376	DSBC-32-30-D3-PPSA-N3
	40	3656514	DSBC-32-40-D3-PPVA-N3	3659377	DSBC-32-40-D3-PPSA-N3
	50	3656515	DSBC-32-50-D3-PPVA-N3	3659378	DSBC-32-50-D3-PPSA-N3
	60	3656516	DSBC-32-60-D3-PPVA-N3	3659379	DSBC-32-60-D3-PPSA-N3
	70	3656517	DSBC-32-70-D3-PPVA-N3	3659380	DSBC-32-70-D3-PPSA-N3
	80	3656518	DSBC-32-80-D3-PPVA-N3	3659381	DSBC-32-80-D3-PPSA-N3
	100	3656519	DSBC-32-100-D3-PPVA-N3	3659382	DSBC-32-100-D3-PPSA-N3
	125	3656520	DSBC-32-125-D3-PPVA-N3	3659383	DSBC-32-125-D3-PPSA-N3
	150	3656521	DSBC-32-150-D3-PPVA-N3	3659384	DSBC-32-150-D3-PPSA-N3
	160	3656522	DSBC-32-160-D3-PPVA-N3	3659385	DSBC-32-160-D3-PPSA-N3
	200	3656523	DSBC-32-200-D3-PPVA-N3	3659386	DSBC-32-200-D3-PPSA-N3
	250	3656524	DSBC-32-250-D3-PPVA-N3	3659387	DSBC-32-250-D3-PPSA-N3
300	3656525	DSBC-32-300-D3-PPVA-N3	3659388	DSBC-32-300-D3-PPSA-N3	
320	3656526	DSBC-32-320-D3-PPVA-N3	3659389	DSBC-32-320-D3-PPSA-N3	
40	20	3660615	DSBC-40-20-D3-PPVA-N3	3660759	DSBC-40-20-D3-PPSA-N3
	25	3660616	DSBC-40-25-D3-PPVA-N3	3660760	DSBC-40-25-D3-PPSA-N3
	30	3660617	DSBC-40-30-D3-PPVA-N3	3660761	DSBC-40-30-D3-PPSA-N3
	40	3660618	DSBC-40-40-D3-PPVA-N3	3660762	DSBC-40-40-D3-PPSA-N3
	50	3660619	DSBC-40-50-D3-PPVA-N3	3660763	DSBC-40-50-D3-PPSA-N3
	60	3660620	DSBC-40-60-D3-PPVA-N3	3660764	DSBC-40-60-D3-PPSA-N3
	70	3660621	DSBC-40-70-D3-PPVA-N3	3660765	DSBC-40-70-D3-PPSA-N3
	80	3660622	DSBC-40-80-D3-PPVA-N3	3660766	DSBC-40-80-D3-PPSA-N3
	100	3660623	DSBC-40-100-D3-PPVA-N3	3660767	DSBC-40-100-D3-PPSA-N3
	125	3660624	DSBC-40-125-D3-PPVA-N3	3660768	DSBC-40-125-D3-PPSA-N3
	150	3660625	DSBC-40-150-D3-PPVA-N3	3660769	DSBC-40-150-D3-PPSA-N3
	160	3660626	DSBC-40-160-D3-PPVA-N3	3660770	DSBC-40-160-D3-PPSA-N3
	200	3660627	DSBC-40-200-D3-PPVA-N3	3660771	DSBC-40-200-D3-PPSA-N3
	250	3660628	DSBC-40-250-D3-PPVA-N3	3660772	DSBC-40-250-D3-PPSA-N3
300	3660629	DSBC-40-300-D3-PPVA-N3	3660773	DSBC-40-300-D3-PPSA-N3	
320	3660630	DSBC-40-320-D3-PPVA-N3	3660774	DSBC-40-320-D3-PPSA-N3	

Data sheet

Ordering data – Versions for DSBC-...D3 (sensor slots on 3 sides)

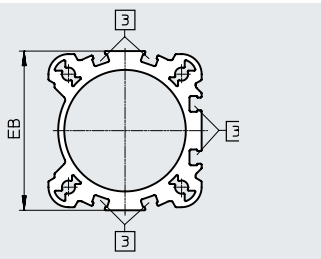

In this version, the piston position can be sensed on 3 sides of the drive.

[3] Sensor slot for proximity switch

Piston diameter [mm]	Stroke [mm]	With PPV cushioning		With PPS cushioning	
		Part no.	Type	Part no.	Type
50	20	3659467	DSBC-50-20-D3-PPVA-N3	3659491	DSBC-50-20-D3-PPSA-N3
	25	3659468	DSBC-50-25-D3-PPVA-N3	3659492	DSBC-50-25-D3-PPSA-N3
	30	3659469	DSBC-50-30-D3-PPVA-N3	3659493	DSBC-50-30-D3-PPSA-N3
	40	3659470	DSBC-50-40-D3-PPVA-N3	3659494	DSBC-50-40-D3-PPSA-N3
	50	3659471	DSBC-50-50-D3-PPVA-N3	3659495	DSBC-50-50-D3-PPSA-N3
	60	3659472	DSBC-50-60-D3-PPVA-N3	3659496	DSBC-50-60-D3-PPSA-N3
	70	3659473	DSBC-50-70-D3-PPVA-N3	3659497	DSBC-50-70-D3-PPSA-N3
	80	3659474	DSBC-50-80-D3-PPVA-N3	3659498	DSBC-50-80-D3-PPSA-N3
	100	3659475	DSBC-50-100-D3-PPVA-N3	3659499	DSBC-50-100-D3-PPSA-N3
	125	3659476	DSBC-50-125-D3-PPVA-N3	3659500	DSBC-50-125-D3-PPSA-N3
	150	3659477	DSBC-50-150-D3-PPVA-N3	3659501	DSBC-50-150-D3-PPSA-N3
	160	3659478	DSBC-50-160-D3-PPVA-N3	3659502	DSBC-50-160-D3-PPSA-N3
	200	3659479	DSBC-50-200-D3-PPVA-N3	3659503	DSBC-50-200-D3-PPSA-N3
	250	3659480	DSBC-50-250-D3-PPVA-N3	3659504	DSBC-50-250-D3-PPSA-N3
300	3659481	DSBC-50-300-D3-PPVA-N3	3659505	DSBC-50-300-D3-PPSA-N3	
320	3659482	DSBC-50-320-D3-PPVA-N3	3659506	DSBC-50-320-D3-PPSA-N3	
63	20	3657859	DSBC-63-20-D3-PPVA-N3	3657811	DSBC-63-20-D3-PPSA-N3
	25	3657860	DSBC-63-25-D3-PPVA-N3	3657812	DSBC-63-25-D3-PPSA-N3
	30	3657861	DSBC-63-30-D3-PPVA-N3	3657813	DSBC-63-30-D3-PPSA-N3
	40	3657862	DSBC-63-40-D3-PPVA-N3	3657814	DSBC-63-40-D3-PPSA-N3
	50	3657863	DSBC-63-50-D3-PPVA-N3	3657815	DSBC-63-50-D3-PPSA-N3
	60	3657864	DSBC-63-60-D3-PPVA-N3	3657816	DSBC-63-60-D3-PPSA-N3
	70	3657865	DSBC-63-70-D3-PPVA-N3	3657817	DSBC-63-70-D3-PPSA-N3
	80	3657866	DSBC-63-80-D3-PPVA-N3	3657818	DSBC-63-80-D3-PPSA-N3
	100	3657867	DSBC-63-100-D3-PPVA-N3	3657819	DSBC-63-100-D3-PPSA-N3
	125	3657868	DSBC-63-125-D3-PPVA-N3	3657820	DSBC-63-125-D3-PPSA-N3
	150	3657869	DSBC-63-150-D3-PPVA-N3	3657821	DSBC-63-150-D3-PPSA-N3
	160	3657870	DSBC-63-160-D3-PPVA-N3	3657822	DSBC-63-160-D3-PPSA-N3
	200	3657871	DSBC-63-200-D3-PPVA-N3	3657823	DSBC-63-200-D3-PPSA-N3
	250	3657872	DSBC-63-250-D3-PPVA-N3	3657824	DSBC-63-250-D3-PPSA-N3
300	3657873	DSBC-63-300-D3-PPVA-N3	3657825	DSBC-63-300-D3-PPSA-N3	
320	3657874	DSBC-63-320-D3-PPVA-N3	3657826	DSBC-63-320-D3-PPSA-N3	

## Data sheet

## Ordering data – Versions for DSBC-...D3 (sensor slots on 3 sides)

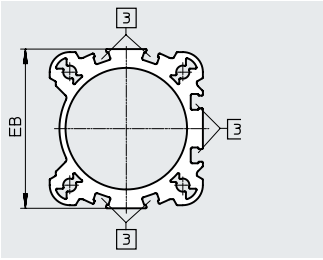

In this version, the piston position can be sensed on 3 sides of the drive.

[3] Sensor slot for proximity switch

Piston diameter [mm]	Stroke [mm]	With PPV cushioning		With PPS cushioning	
		Part no.	Type	Part no.	Type
80	20	3656631	DSBC-80-20-D3-PPVA-N3	3656854	DSBC-80-20-D3-PPSA-N3
	25	3656632	DSBC-80-25-D3-PPVA-N3	3656855	DSBC-80-25-D3-PPSA-N3
	30	3656633	DSBC-80-30-D3-PPVA-N3	3656856	DSBC-80-30-D3-PPSA-N3
	40	3656634	DSBC-80-40-D3-PPVA-N3	3656857	DSBC-80-40-D3-PPSA-N3
	50	3656635	DSBC-80-50-D3-PPVA-N3	3656858	DSBC-80-50-D3-PPSA-N3
	60	3656636	DSBC-80-60-D3-PPVA-N3	3656859	DSBC-80-60-D3-PPSA-N3
	70	3656637	DSBC-80-70-D3-PPVA-N3	3656860	DSBC-80-70-D3-PPSA-N3
	80	3656638	DSBC-80-80-D3-PPVA-N3	3656861	DSBC-80-80-D3-PPSA-N3
	100	3656639	DSBC-80-100-D3-PPVA-N3	3656862	DSBC-80-100-D3-PPSA-N3
	125	3656640	DSBC-80-125-D3-PPVA-N3	3656863	DSBC-80-125-D3-PPSA-N3
	150	3656641	DSBC-80-150-D3-PPVA-N3	3656864	DSBC-80-150-D3-PPSA-N3
	160	3656642	DSBC-80-160-D3-PPVA-N3	3656865	DSBC-80-160-D3-PPSA-N3
	200	3656643	DSBC-80-200-D3-PPVA-N3	3656866	DSBC-80-200-D3-PPSA-N3
	250	3656644	DSBC-80-250-D3-PPVA-N3	3656867	DSBC-80-250-D3-PPSA-N3
	300	3656645	DSBC-80-300-D3-PPVA-N3	3656868	DSBC-80-300-D3-PPSA-N3
	320	3656646	DSBC-80-320-D3-PPVA-N3	3656869	DSBC-80-320-D3-PPSA-N3

## Accessories

### Foot mounting HNC/CRHNC

Material:

HNC: Galvanised steel

CRHNC: High-alloy steel

Free of copper and PTFE

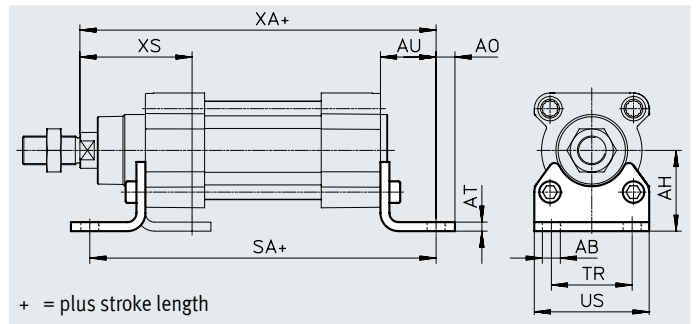

#### Dimensions and ordering data

For diam. [mm]	AB ∅	AH	AO	AT	AU	SA		TR	US	XA		XS
						DSBC...	DSBC...-C			DSBC...	DSBC...-C	
32	7	32	6.5	4	24	142	187	32	45	143.1	188.1	46
40	10	36	9	4	28	161	214	36	54	161.9	214.9	52.7
50	10	45	9.5	5	32	170	237	45	64	173.8	240.8	62.6
63	10	50	12.5	5	32	185	261	50	75	189.1	265.1	62.9
80	12	63	15	6	41	210	305	63	93	214.6	309.6	80.4
100	14.5	71	17.5	6	41	220	318	75	110	228.5	326.7	84.3
125	16.5	90	22	8	45	250	375	90	131	270	394.3	102

For diam. [mm]	Basic type				Corrosion-resistant			
	CRC <sup>1)</sup>	Weight [g]	Part no.	Type <sup>2)</sup>	CRC <sup>1)</sup>	Weight [g]	Part no.	Type <sup>2)</sup>
32	2	144	★ 174369	HNC-32	4	139	176937	CRHNC-32
40	2	193	★ 174370	HNC-40	4	188	176938	CRHNC-40
50	2	353	★ 174371	HNC-50	4	341	176939	CRHNC-50
63	2	436	★ 174372	HNC-63	4	424	176940	CRHNC-63
80	2	829	★ 174373	HNC-80	4	809	176941	CRHNC-80
100	2	1009	174374	HNC-100	4	990	176942	CRHNC-100
125	2	1902	174375	HNC-125	4	1920	176943	CRHNC-125

1) Corrosion resistance class CRC 2 to Festo standard FN 940070

Moderate corrosion stress. Indoor applications in which condensation can occur. External visible parts with primarily decorative surface requirements which are in direct contact with a normal industrial environment.

Corrosion resistance class CRC 4 to Festo standard FN 940070

Particularly high corrosion stress. Outdoor exposure under extreme corrosive conditions. Parts exposed to aggressive media, e.g. in the chemical or food industries. Such applications may need to be safeguarded by special tests (→ also FN 940082), using appropriate media.

2) Suitable for ATEX



## Accessories

## Flange mounting FNC/CRFNG

Material:

FNC: Galvanised steel

CRFNG: High-alloy steel

Free of copper and PTFE

RoHS-compliant

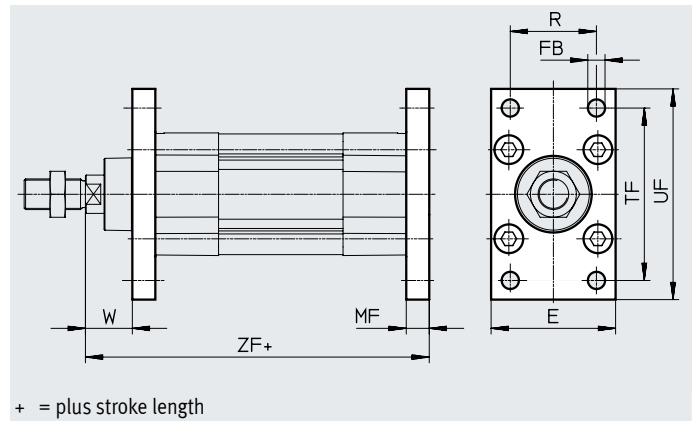

## Dimensions and ordering data

For diam. [mm]	E	FB ∅ H13	MF	R	TF	UF	W	ZF	
								DSBC...	DSBC...-C
32	45	7	10	32	64	80	16	129.1	174.1
40	54	9	10	36	72	90	18.7	143.9	196.9
50	65	9	12	45	90	110	23.6	153.8	220.8
63	75	9	12	50	100	120	23.9	169.1	245.1
80	93	12	16	63	126	150	29.4	189.6	284.6
100	110	14	16	75	150	175	33.3	203.5	301.7
125	132	16	20	90	180	210	45	245	369.3

For diam. [mm]	Basic type				Corrosion-resistant			
	CRC <sup>1)</sup>	Weight [g]	Part no.	Type <sup>2)</sup>	CRC <sup>1)</sup>	Weight [g]	Part no.	Type <sup>2)</sup>
32	1	221	★ 174376	FNC-32	4	220	161846	CRFNG-32
40	1	291	★ 174377	FNC-40	4	291	161847	CRFNG-40
50	1	536	★ 174378	FNC-50	4	526	161848	CRFNG-50
63	1	679	★ 174379	FNC-63	4	680	161849	CRFNG-63
80	1	1495	★ 174380	FNC-80	4	1508	161850	CRFNG-80
100	1	2041	174381	FNC-100	4	2054	161851	CRFNG-100
125	1	3775	174382	FNC-125	4	3787	185363	CRFNG-125

1) Corrosion resistance class CRC 1 to Festo standard FN 940070

Low corrosion stress. Dry internal application or transport and storage protection. Also applies to parts behind coverings, in the non-visible interior area, and parts which are covered in the application (e.g. drive trunnions).

Corrosion resistance class CRC 4 to Festo standard FN 940070

Particularly high corrosion stress. Outdoor exposure under extreme corrosive conditions. Parts exposed to aggressive media, e.g. in the chemical or food industries. Such applications may need to be safeguarded by special tests (→ also FN 940082), using appropriate media.

1) Suitable for ATEX

## Accessories

### Trunnion flange ZNCF/CRZNG

Material:

ZNCF: Stainless steel casting

CRZNG: Electropolished stainless steel casting

Free of copper and PTFE

RoHS-compliant

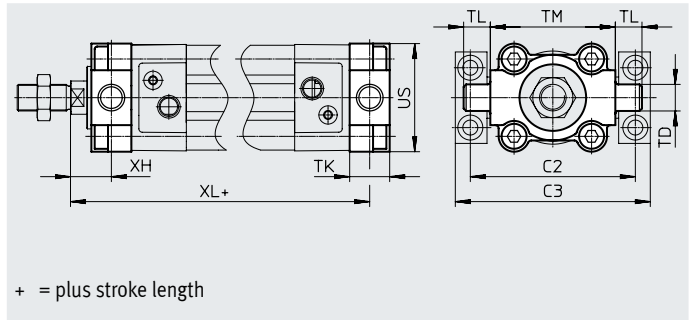

#### Dimensions and ordering data

For diam. [mm]	C2	C3	TD ø e9	TK	TL	TM	US	XH	XL	
									DSBC...	DSBC...-C
32	71	86	12	16	12	50	45	18	127.1	172.1
40	87	105	16	20	16	63	54	18.7	143.9	196.9
50	99	117	16	24	16	75	64	23.6	153.8	220.8
63	116	136	20	24	20	90	75	23.9	169.1	245.1
80	136	156	20	28	20	110	93	31.4	187.6	282.6
100	164	189	25	38	25	132	110	30.3	206.5	304.7
125	192	217	25	50	25	160	131	40	250	374.3

For diam. [mm]	Basic type				Corrosion-resistant			
	CRC <sup>1)</sup>	Weight [g]	Part no.	Type <sup>2)</sup>	CRC <sup>1)</sup>	Weight [g]	Part no.	Type <sup>2)</sup>
32	2	150	174411	ZNCF-32	4	150	161852	CRZNG-32
40	2	285	174412	ZNCF-40	4	285	161853	CRZNG-40
50	2	473	174413	ZNCF-50	4	473	161854	CRZNG-50
63	2	687	174414	ZNCF-63	4	687	161855	CRZNG-63
80	2	1296	174415	ZNCF-80	4	1296	161856	CRZNG-80
100	2	2254	174416	ZNCF-100	4	2254	161857	CRZNG-100
125	2	3484	174417	ZNCF-125	4	3484	185362	CRZNG-125

1) Corrosion resistance class CRC 2 to Festo standard FN 940070

Moderate corrosion stress. Indoor applications in which condensation can occur. External visible parts with primarily decorative surface requirements which are in direct contact with a normal industrial environment.

Corrosion resistance class CRC 4 to Festo standard FN 940070

Particularly high corrosion stress. Outdoor exposure under extreme corrosive conditions. Parts exposed to aggressive media, e.g. in the chemical or food industries. Such applications may need to be safeguarded by special tests (→ also FN 940082), using appropriate media.

1) Suitable for ATEX

## Accessories

### Trunnion support LNZG

Material:

Trunnion support: Anodised aluminium

Plain bearing: Plastic

Free of copper and PTFE

RoHS-compliant

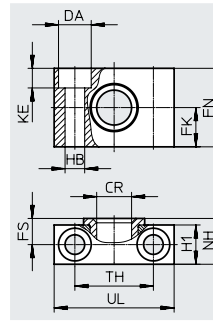
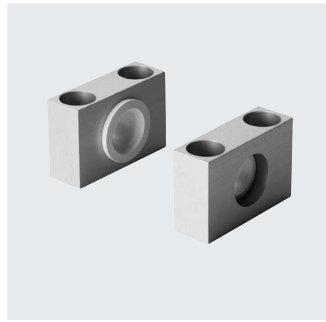

Dimensions and ordering data														Weight	Part no.	Type
For diam.	CR	DA	FK	FN	FS	H1	HB	KE	NH	TH	UL	CRC <sup>1)</sup>				
[mm]	∅ D11	∅ H13	∅ ±0.1				∅ H13			±0.2			[g]			
32	12	11	15	30	10.5	15	6.6	6.8	18	32	46	2	90	<b>32959</b>	<b>LNZG-32</b>	
40, 50	16	15	18	36	12	18	9	9	21	36	55	2	140	<b>32960</b>	<b>LNZG-40/50</b>	
63, 80	20	18	20	40	13	20	11	11	23	42	65	2	190	<b>32961</b>	<b>LNZG-63/80</b>	
100, 125	25	20	25	50	16	24.5	14	13	28.5	50	75	2	320	<b>32962</b>	<b>LNZG-100/125</b>	

1) Corrosion resistance class CRC 2 to Festo standard FN 940070

Moderate corrosion stress. Indoor applications in which condensation can occur. External visible parts with primarily decorative surface requirements which are in direct contact with a normal industrial environment.

### Trunnion support CRLNZG

Material:

High-alloy steel

Free of copper and PTFE

RoHS-compliant

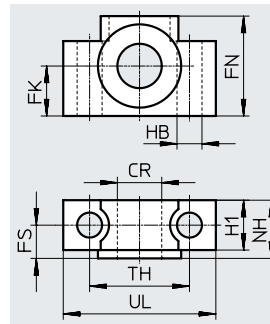
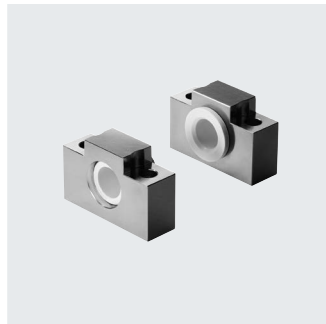

Dimensions and ordering data												Weight	Part no.	Type
For diam.	CR	FK	FN	FS	H1	HB	NH	TH	UL	CRC <sup>1)</sup>				
[mm]	∅ D11	∅ ±0.1				∅ H13		±0.2			[g]			
32	12	15	30	10.5	15	6.6	18	32	46	4	205	<b>161874</b>	<b>CRLNZG-32</b>	
40, 50	16	18	36	12	18	9	21	36	55	4	323	<b>161875</b>	<b>CRLNZG-40/50</b>	
63, 80	20	20	40	13	20	11	23	42	65	4	435	<b>161876</b>	<b>CRLNZG-63/80</b>	
100, 125	25	25	50	16	24.5	14	28.5	50	75	4	739	<b>161877</b>	<b>CRLNZG-100/125</b>	

1) Corrosion resistance class CRC 4 to Festo standard FN 940070

Particularly high corrosion stress. Outdoor exposure under extreme corrosive conditions. Parts exposed to aggressive media, e.g. in the chemical or food industries. Such applications may need to be safeguarded by special tests (→ also FN 940082), using appropriate media.

## Accessories

### Swivel flange SNC

Material:  
Die-cast aluminium  
Free of copper and PTFE  
RoHS-compliant

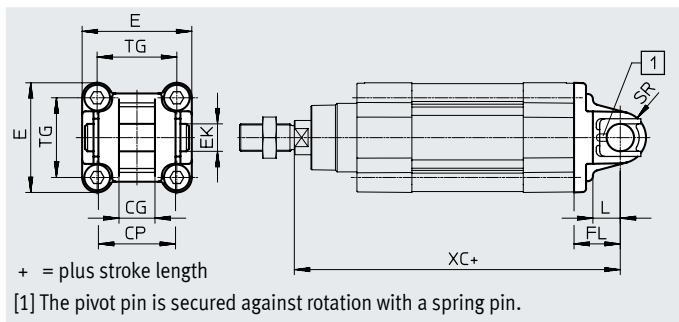

#### Dimensions and ordering data

For diam.	CG	CP	E	EK ∅	FL	L	SR
[mm]	H14	h14		H9	±0.2		
32	14	34	45 <sup>+0.2/-0.5</sup>	10	22	13	10
40	16	40	54 <sup>-0.5</sup>	12	25	16	12
50	21	45	64 <sup>-0.6</sup>	16	27	16	12
63	21	51	75 <sup>-0.6</sup>	16	32	21	16
80	25	65	93 <sup>-0.8</sup>	20	36	22	16
100	25	75	110 <sup>+0.3/-0.8</sup>	20	41	27	20
125	37	97	131 <sup>-0.8</sup>	30	50	30	25

For diam.	TG	XC		CRC <sup>1)</sup>	Weight [g]	Part no.	Type <sup>2)</sup>
		DSBC...	DSBC...-C				
32	32.5	141.1	186.1	1	93	★ 174383	SNC-32
40	38	158.9	211.9	1	140	★ 174384	SNC-40
50	46.5	168.8	235.8	1	234	★ 174385	SNC-50
63	56.5	189.1	265.1	1	331	★ 174386	SNC-63
80	72	209.6	304.6	1	618	★ 174387	SNC-80
100	89	228.5	326.7	1	865	174388	SNC-100
125	110	275	399.3	1	1728	174389	SNC-125

- 1) Corrosion resistance class CRC 1 to Festo standard FN 940070  
Low corrosion stress. Dry internal application or transport and storage protection. Also applies to parts behind coverings, in the non-visible interior area, and parts which are covered in the application (e.g. drive trunnions).
- 2) Suitable for ATEX

## Accessories

Swivel flange  
SNCB/SNCB-...-R3

Material:  
 SNCB: Die-cast aluminium  
 SNCB-...-R3: die-cast aluminium with  
 protective coating  
 Free of copper and PTFE  
 RoHS-compliant

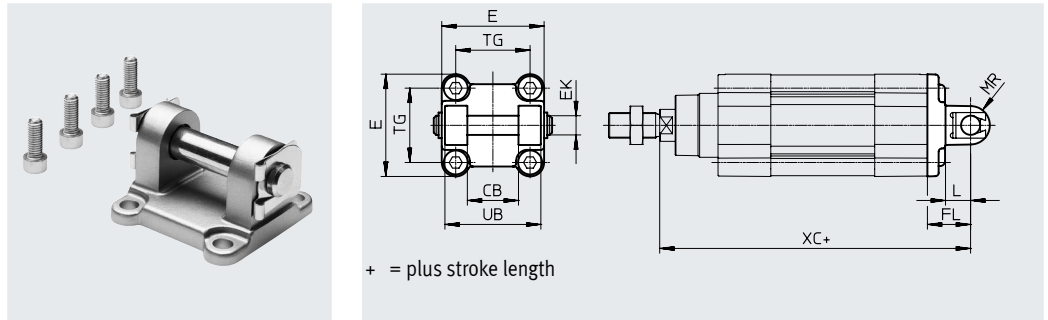

## Dimensions and ordering data

For diam. [mm]	CB H14	E 45 <sup>+0.2</sup> / <sub>-0.5</sub>	EK ∅ H9/e8	FL ±0.2	L	MR -0.5	TG	UB h14	XC	
									DSBC...	DSBC... C
32	26	45 <sup>+0.2</sup> / <sub>-0.5</sub>	10	22	13	8.5	32.5	45	141.1	186.1
40	28	54 <sub>-0.5</sub>	12	25	16	12	38	52	158.9	211.9
50	32	64 <sub>-0.6</sub>	12	27	16	12	46.5	60	168.8	235.8
63	40	75 <sub>-0.6</sub>	16	32	21	16	56.5	70	189.1	265.1
80	50	93 <sub>-0.8</sub>	16	36	22	16	72	90	209.6	304.6
100	60	110 <sup>+0.3</sup> / <sub>-0.8</sub>	20	41	27	20	89	110	228.5	326.7
125	70	131 <sub>-0.8</sub>	25	50	30	25	110	130	275	399.3

For diam. [mm]	Basic type				R3 – High corrosion protection			
	CRC <sup>1)</sup>	Weight [g]	Part no.	Type	CRC <sup>1)</sup>	Weight [g]	Part no.	Type
32	1	103	★ 174390	SNCB-32	3	100	176944	SNCB-32-R3
40	1	155	★ 174391	SNCB-40	3	151	176945	SNCB-40-R3
50	1	232	★ 174392	SNCB-50	3	228	176946	SNCB-50-R3
63	1	375	★ 174393	SNCB-63	3	371	176947	SNCB-63-R3
80	1	636	★ 174394	SNCB-80	3	632	176948	SNCB-80-R3
100	1	1035	174395	SNCB-100	3	986	176949	SNCB-100-R3
125	1	1860	174396	SNCB-125	3	1776	176950	SNCB-125-R3

1) Corrosion resistance class CRC 1 to Festo standard FN 940070

Low corrosion stress. Dry internal application or transport and storage protection. Also applies to parts behind coverings, in the non-visible interior area, and parts which are covered in the application (e.g. drive trunnions).

Corrosion resistance class CRC 3 to Festo standard FN 940070

High corrosion stress. Outdoor exposure under moderate corrosive conditions. Externally visible parts with primarily functional surface requirements which are in direct contact with a normal industrial environment.

## Accessories

### Swivel flange

SNCS/CRSNCS/SNCS-...-R3

Material:

SNCS 32 ... 50: Die-cast aluminium

SNCS 63 ... 125:

Wrought aluminium alloy

CRSNCS 32 ... 80:

High-alloy stainless steel

SNCS-...-R3 100 ... 125:

Wrought aluminium alloy with

protective coating

RoHS-compliant

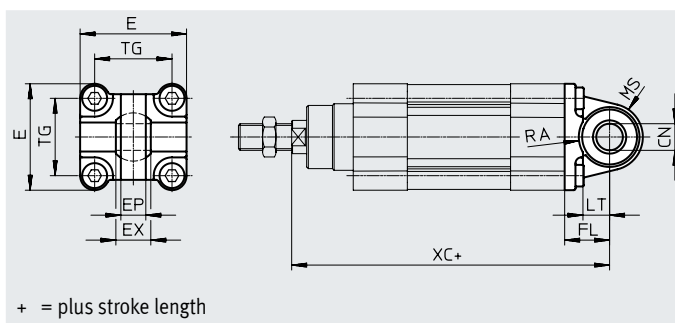

+ = plus stroke length

### Dimensions and ordering data

For diam. [mm]	CN ∅		E		EP ±0.2	EX	FL ±0.2	LT
	DSBC...	DSBC...-R3	DSBC...	DSBC...-R3				
32	10 <sup>+0.013</sup>	10+0.015/-0.04	45+0.2/-0.5	45-0.5	10.5	14	22	13
40	12 <sup>+0.015</sup>	12+0.018/-0.04	54 <sub>-0.5</sub>	54 <sub>-0.5</sub>	12	16	25	16
50	16 <sup>+0.015</sup>	16+0.018/-0.04	64 <sub>-0.6</sub>	64 <sub>-0.6</sub>	15	21	27	16
63	16 <sup>+0.015</sup>	16+0.018/-0.04	74.5±0.5	75 <sub>-0.6</sub>	15	21	32	21
80	20 <sup>+0.018</sup>	20+0.021/-0.04	92.2±0.8	93 <sub>-0.8</sub>	18	25	36	22
100	20 <sup>+0.018</sup>	20+0.021/-0.04	109+1/-0.7	109+1/-0.7	18	25	41	27
125	30 <sup>+0.018</sup>	30+0.021/-0.04	132+1/-0.7	132+1/-0.7	25	37	50	30

For diam. [mm]	MS		RA		TG	XC	
	DSBC...	DSBC...-R3	DSBC... +1	DSBC...-R3 +1		DSBC...	DSBC...-C
32	15 <sup>+0.5</sup>	15 <sup>+0.5</sup>	14.5	14.5	32.5	141.1	186.1
40	17 <sup>+0.5</sup>	17 <sup>+0.5</sup>	17.5	17.5	38	158.9	211.9
50	20 <sup>+0.5</sup>	20 <sup>+0.5</sup>	18.5	19	46.5	168.8	235.8
63	23 <sub>-0.5</sub>	22 <sup>+0.5</sup>	23	23	56.5	189.1	265.1
80	28 <sub>-0.5</sub>	27 <sup>+0.5</sup>	25	25	72	209.6	304.6
100	30±0.5	30±0.5	95	100	89	228.5	326.7
125	39±0.5	39±0.5	100	100	110	275	326.7

For diam. [mm]	Basic type				High corrosion protection			
	CRC <sup>1)</sup>	Weight [g]	Part no.	Type	CRC <sup>1)</sup>	Weight [g]	Part no.	Type
32	1	86	★ 174397	SNCS-32	4	161	2895920	CRSNCS-32
40	1	122	★ 174398	SNCS-40	4	239	2895921	CRSNCS-40
50	1	216	★ 174399	SNCS-50	4	403	2895922	CRSNCS-50
63	2	281	★ 174400	SNCS-63	4	576	2895923	CRSNCS-63
80	2	557	★ 174401	SNCS-80	4	1173	2895924	CRSNCS-80
100	2	683	174402	SNCS-100	3	684	2895925	SNCS-100-R3
125	2	1369	174403	SNCS-125	3	1369	2895926	SNCS-125-R3

1) Corrosion resistance class CRC 1 to Festo standard FN 940070

Low corrosion stress. Dry internal application or transport and storage protection. Also applies to parts behind coverings, in the non-visible interior area, and parts which are covered in the application (e.g. drive trunnions).

Corrosion resistance class CRC 2 to Festo standard FN 940070

Moderate corrosion stress. Indoor applications in which condensation can occur. External visible parts with primarily decorative surface requirements which are in direct contact with a normal industrial environment.

Corrosion resistance class CRC 3 to Festo standard FN 940070

High corrosion stress. Outdoor exposure under moderate corrosive conditions. Externally visible parts with primarily functional surface requirements which are in direct contact with a normal industrial environment.

Corrosion resistance class CRC 4 to Festo standard FN 940070

Particularly high corrosion stress. Outdoor exposure under extreme corrosive conditions. Parts exposed to aggressive media, e.g. in the chemical or food industries. Such applications may need to be safeguarded by special tests

(→ also FN 940082), using appropriate media.

## Accessories

## Swivel flange SNCL

Material:  
Die-cast aluminium  
Free of copper and PTFE  
RoHS-compliant

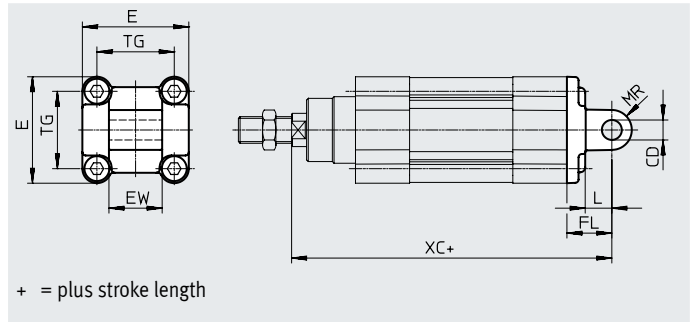

## Dimensions and ordering data

For diam.	CD	E	EW	FL	L	MR
[mm]	∅ H9		h12	±0.2		
32	10	45 <sup>+0.2/-0.5</sup>	26	22	13	10
40	12	54 <sup>-0.5</sup>	28	25	16	12
50	12	64 <sup>-0.6</sup>	32	27	16	12
63	16	75 <sup>-0.6</sup>	40	32	21	16
80	16	93 <sup>-0.8</sup>	50	36	22	16
100	20	110 <sup>+0.3/-0.8</sup>	60	41	27	20
125	25	131 <sup>-0.8</sup>	70	50	30	25

For diam.	TG	XC		CRC <sup>1)</sup>	Weight	Part no.	Type
		DSBC...	DSBC....C				
[mm]					[g]		
32	32.5	141.1	186.1	1	71	★ 174404	SNCL-32
40	38	158.9	211.9	1	95	★ 174405	SNCL-40
50	46.5	168.8	235.8	1	158	★ 174406	SNCL-50
63	56.5	189.1	265.1	1	225	★ 174407	SNCL-63
80	72	209.6	304.6	1	436	★ 174408	SNCL-80
100	89	228.5	326.7	1	606	174409	SNCL-100
125	110	275	399.3	1	1135	174410	SNCL-125

1) Corrosion resistance class CRC 1 to Festo standard FN 940070

Low corrosion stress. Dry internal application or transport and storage protection. Also applies to parts behind coverings, in the non-visible interior area, and parts which are covered in the application (e.g. drive trunnions).

## Accessories

### Trunnion flange kit DAMT

The kit can be attached at any position along the profile barrel of the cylinder.

Material:  
Galvanised steel  
RoHS-compliant

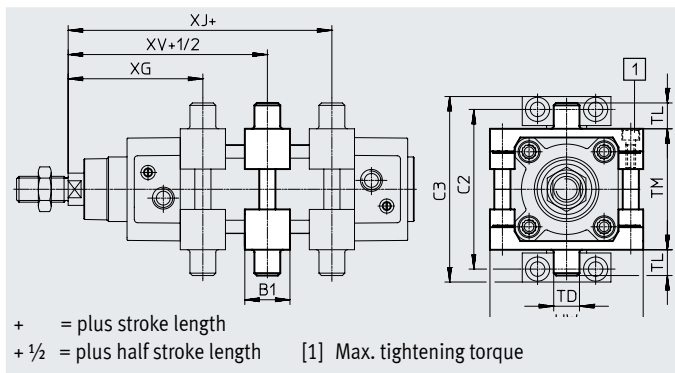
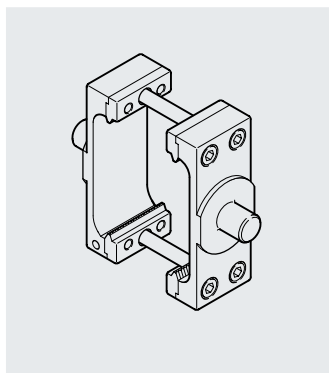

#### Dimensions and ordering data

For diam.	B1	C2	C3	TD ∅ e9	TL	TM	UW
[mm]							
32	30	71	86	12	12	50	65
40	32	87	105	16	16	63	75
50	34	99	117	16	16	75	95
63	41	116	136	20	20	90	105
80	44	136	156	20	20	110	130
100	48	164	189	25	25	132	145
125	50	192	217	25	25	160	177

For diam.	XG	XJ	XV	Max. tightening torque [Nm]	CRC <sup>1)</sup>	Weight [g]	Part no.	Type <sup>2)</sup>
[mm]	min.	max.						
32	69±1.4	76±1.4	73±1.4	4+1	1	213	★ 2213233	DAMT-V1-32-A
40	77.7±1.4	84.9±1.4	81.2±1.4	8+1	1	388	★ 2214899	DAMT-V1-40-A
50	85.6±1.4	91.8±1.4	88.6±1.4	8+2	1	608	★ 2214909	DAMT-V1-50-A
63	96.9±1.8	96.1±1.8	96.4±1.8	18+2	1	911	★ 2214971	DAMT-V1-63-A
80	110.4±1.8	108.6±1.8	109.4±1.8	28+2	1	1494	★ 163529	DAMT-V1-80-A
100	121.3±1.8	115.5±1.8	118.3±1.8	28+2	1	2095	163530	DAMT-V1-100-A
125	134.7±1.8	155.3±1.8	145±1.8	40+2	1	3548	1812524	DAMT-V8-125-A

1) Corrosion resistance class CRC 1 to Festo standard FN 940070



Low corrosion stress. Dry internal application or transport and storage protection. Also applies to parts behind coverings, in the non-visible interior area, and parts which are covered in the application (e.g. drive trunnions).

2) Suitable for ATEX



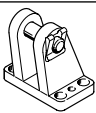

## Accessories

## Ordering data – Mounting components

Designation	For diam.	Part no.	Type
<b>Clevis foot LNG</b>			
	32	★ 33890	LNG-32
	40	★ 33891	LNG-40
	50	★ 33892	LNG-50
	63	★ 33893	LNG-63
	80	★ 33894	LNG-80
	100	33895	LNG-100
	125	33896	LNG-125
<b>Clevis foot LSNG</b>			
	32	31740	LSNG-32
	40	31741	LSNG-40
	50	31742	LSNG-50
	63	31743	LSNG-63
	80	31744	LSNG-80
	100	31745	LSNG-100
	125	31746	LSNG-125
<b>Clevis foot LBG<sup>1)</sup></b>			
	32	31761	LBG-32
	40	31762	LBG-40
	50	31763	LBG-50
	63	31764	LBG-63
	80	31765	LBG-80
	100	31766	LBG-100
	125	31767	LBG-125

1) Suitable for ATEX

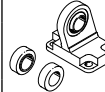
## Ordering data – Mounting components

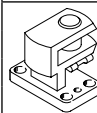
Designation	For diam.	Part no.	Type
<b>Clevis foot LSN</b>			
	32	5561	LSN-32
	40	5562	LSN-40
	50	5563	LSN-50
	63	5564	LSN-63
	80	5565	LSN-80
	100	5566	LSN-100
	125	6987	LSN-125
<b>Clevis foot LSNSG</b>			
	32	31747	LSNSG-32
	40	31748	LSNSG-40
	50	31749	LSNSG-50
	63	31750	LSNSG-63
	80	31751	LSNSG-80
	100	31752	LSNSG-100
	125	31753	LSNSG-125
<b>Right-angle clevis foot LQG<sup>1)</sup></b>			
	32	31768	LQG-32
	40	31769	LQG-40
	50	31770	LQG-50
	63	31771	LQG-63
	80	31772	LQG-80
	100	31773	LQG-100
	125	31774	LQG-125

## Ordering data – Mounting components, corrosion-resistant

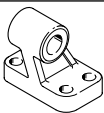
Designation	For diam.	Part no.	Type
<b>Clevis foot CRLNG</b>			
	32	161840	CRLNG-32
	40	161841	CRLNG-40
	50	161842	CRLNG-50
	63	161843	CRLNG-63
	80	161844	CRLNG-80
	100	161845	CRLNG-100
	125	176951	CRLNG-125

## Ordering data – Mounting components, high corrosion protection

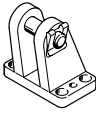
Designation	For diam.	Part no.	Type
<b>Clevis foot LBG-R3</b>			
	32	2078790	LBG-32-R3
	40	2078792	LBG-40-R3
	50	2078794	LBG-50-R3
	63	2078795	LBG-63-R3
	80	2078797	LBG-80-R3
	100	2078799	LBG-100-R3
	125	2078837	LBG-125-R3

## Accessories

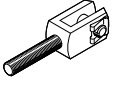
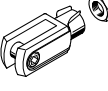
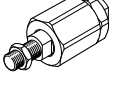
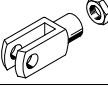
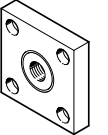
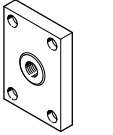
Ordering data – Piston rod attachments				Data sheets → Internet: piston rod attachment				
Designation	For diam.	Part no.	Type	Designation	For diam.	Part no.	Type	
<b>Rod eye SGS</b>				<b>Rod clevis SGA<sup>1)</sup></b>				
	32	★ 9261	SGS-M10x1.25		32	32954	SGA-M10x1.25	
	40	★ 9262	SGS-M12x1.25		40	10767	SGA-M12x1.25	
	50	★ 9263	SGS-M16x1.5		50	10768	SGA-M16x1.5	
	63				63			
	80	★ 9264	SGS-M20x1.5		80	10769	SGA-M20x1.5	
	100				100			
	125	10774	SGS-M27x2		125	10770	SGA-M27x2	
<b>Rod clevis SG<sup>1)</sup></b>				<b>Self-aligning rod coupler FK<sup>1)</sup></b>				
	32	★ 6144	SG-M10x1.25		32	★ 6140	FK-M10x1.25	
	40	★ 6145	SG-M12x1.25		40	★ 6141	FK-M12x1.25	
	50	★ 6146	SG-M16x1.5		50	★ 6142	FK-M16x1.5	
	63				63			
	80	★ 6147	SG-M20x1.5	80	★ 6143	FK-M20x1.5		
	100			100				
	125	14987	SG-M27x2-B	125	10485	FK-M27x2		
<b>Coupling piece KSG<sup>1)</sup></b>				<b>Coupling piece KSZ<sup>1)</sup></b>				
	32	32963	KSG-M10x1.25		32	36125	KSZ-M10x1.25	
	40	32964	KSG-M12x1.25		40	36126	KSZ-M12x1.25	
	50	32965	KSG-M16x1.5		50	36127	KSZ-M16x1.5	
	63				63			
	80	32966	KSG-M20x1.5		80	36128	KSZ-M20x1.5	
	100				100			
	125	32967	KSG-M27x2		125	-	-	

1) Suitable for ATEX

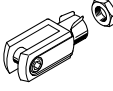
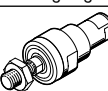
Ordering data – Piston rod attachments, corrosion-resistant				Data sheets → Internet: piston rod attachment				
Designation	For diam.	Part no.	Type	Designation	For diam.	Part no.	Type	
<b>Rod eye CRSGS</b>				<b>Rod clevis CRSG<sup>1)</sup></b>				
	32	195582	CRSGS-M10x1.25		32	13569	CRSG-M10x1.25	
	40	195583	CRSGS-M12x1.25		40	13570	CRSG-M12x1.25	
	50	195584	CRSGS-M16x1.5		50	13571	CRSG-M16x1.5	
	63				63			
	80	195585	CRSGS-M20x1.5		80	13572	CRSG-M20x1.5	
	100				100			
	125	195586	CRSGS-M27x2		125	185361	CRSG-M27x2	
<b>Self-aligning rod coupler CRFK<sup>1)</sup></b>								
	32	2305778	CRFK-M10x1.25					
	40	2305779	CRFK-M12x1.25					
	50	2490673	CRFK-M16x1.5					
	63							
	80	2545677	CRFK-M20x1.5					
	100							

1) Suitable for ATEX

## Accessories

### Bellows kit DADB



#### General technical data

Type DADB-V6-		32	40	50	63	80	100
Max. stroke range of the cylinder <sup>1)</sup>	[mm]	10 ... 500	10 ... 500	10 ... 500	10 ... 500	10 ... 500	10 ... 500
Type of mounting		Via threaded pin					
Mounting position		Any					
Media resistance		Dust, chippings, oil, grease, fuel (→ Internet: media resistance)					
Ambient temperature <sup>2)</sup>	[°C]	-10 ... +80					
Degree of protection		IP54					
Corrosion resistance CRC <sup>3)</sup>		3					

1) In combination with the bellows kit DADB

2) Note operating range of proximity switches and cylinder

3) Corrosion resistance class CRC 3 to Festo standard FN 940070

High corrosion stress. Outdoor exposure under moderate corrosive conditions. Externally visible parts with primarily functional surface requirements which are in direct contact with a normal industrial environment.

#### Materials

##### Sectional view

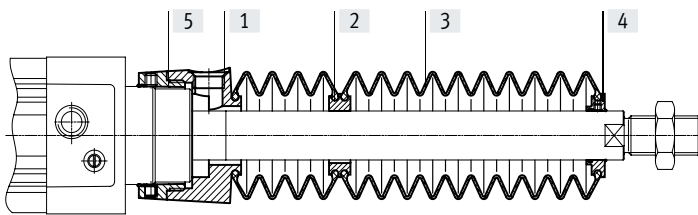

##### Bellows

[1]	Connection	Polyamide
[2]	Adapter	Polyamide
[3]	Bellows	NBR
[4]	End piece	Polyamide
[5]	Connector	Polyamide
-	O-ring	NBR
	Note on materials	Free of copper and PTFE RoHS-compliant

#### Weight [g]

Type DADB-V6- Stroke [mm]	32	40	50	63	80	100
10 ... 50	29	42	71	69	99	124
51 ... 125	41	56	91	89	127	152
126 ... 175	52	68	105	103	140	165
176 ... 250	66	85	129	127	193	218
251 ... 300	79	100	147	145	231	255
301 ... 350	92	115	166	164	268	293
351 ... 375	92	115	167	165	259	284
376 ... 425	104	129	185	183	296	321
426 ... 475	117	144	204	202	334	359
476 ... 500	117	144	205	203	324	349

## Accessories

### Travel speed $v$ as a function of tubing length $l$

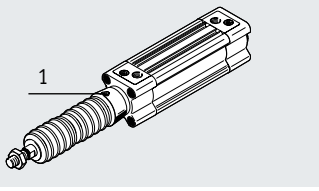

The bellows kit is a leak-free system. To prevent unwanted media from being drawn in, the supply and exhaust air must be ducted via a pressure

compensation hole in the connection part [1]. The pressure generated in the bellows kit by the positioning motion is primarily defined by the travel speed and the

tubing length. The recommended tubing length based on the travel speed of the drive can be read from the graph.

Advancing

Retracting

DADB-32 ... 100

DADB-32 ... 100

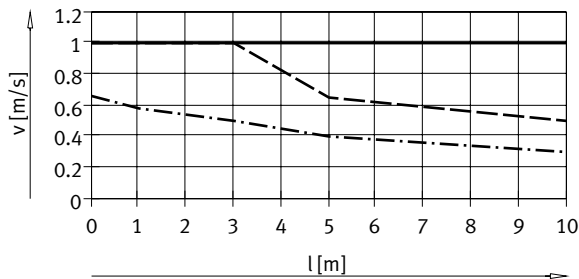

—  $\varnothing$  32/ 50/63  
 - · - · -  $\varnothing$  40  
 - - -  $\varnothing$  80/100

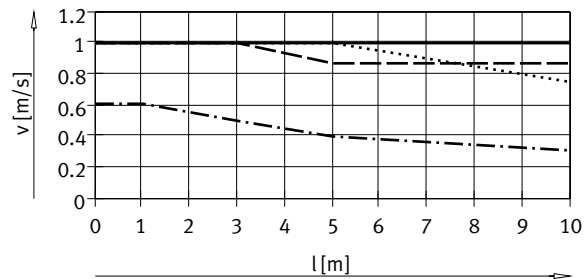

—  $\varnothing$  32  
 - · - · -  $\varnothing$  40  
 - - -  $\varnothing$  50/63  
 ······  $\varnothing$  80/100

#### Note

The push-in fittings in the adjacent table must be used for the pressure compensation hole. Silencers can be used as an alternative. This reduces the travel speed slightly.

#### Tube size and push-in fitting for pressure compensation hole

$\varnothing$ [mm]	Tubing O.D. [mm]	Push-in fitting	
		Part no.	Type
32, 40	8	★ 186109	QS-G1/8-8-I
		578376	NPQH-DK-G18-Q8-P10
		578362	NPQH-D-G18-S8-P10
50, 63, 80, 100	12	★ 186350	QS-G1/4-12
		578344	NPQH-D-G14-Q12-P10
		578366	NPQH-D-G14-S12-P10

Accessories

Dimensions

Download CAD data → [www.festo.com](http://www.festo.com)

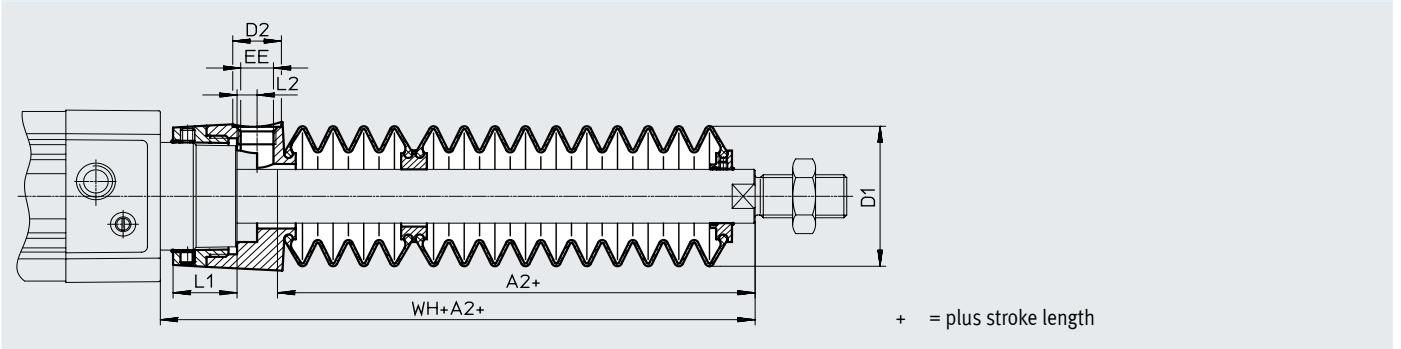

∅ Stroke [mm]	32							40						
	A2 <sup>1)</sup>	D1 max.	D2	EE	L1	L2	WH+A2	A2 <sup>1)</sup>	D1 max.	D2	EE	L1	L2	WH+A2
10 ... 50	29	38	14	G1/8	12.9	5.4	55	28	46	14	G1/8	16.3	5.4	56.7
51 ... 125	47						73	43						71.7
126 ... 175	61						87	56						84.7
176 ... 250	80						106	72						100.7
251 ... 300	96						122	86						114.7
301 ... 350	112						138	100						128.7
351 ... 375	114						140	101						129.7
376 ... 425	130						156	115						143.7
426 ... 475	145						171	130						158.7
476 ... 500	147	173	131	159.7										

∅ Stroke [mm]	50							63						
	A2 <sup>1)</sup>	D1 max.	D2	EE	L1	L2	WH+A2	A2 <sup>1)</sup>	D1 max.	D2	EE	L1	L2	WH+A2
10 ... 50	28	57	17	G1/4	22.35	7	63.6	28	57	17	G1/4	22.4	7	63.9
51 ... 125	46						81.6	46						81.9
126 ... 175	56						91.6	56						91.9
176 ... 250	73						108.6	73						108.9
251 ... 300	86						121.6	86						121.9
301 ... 350	97						132.6	97						132.9
351 ... 375	105						140.6	105						140.9
376 ... 425	116						151.6	116						151.9
426 ... 475	126						161.6	126						161.9
476 ... 500	134	169.6	134	169.9										

∅ Stroke [mm]	80							100						
	A2 <sup>1)</sup>	D1 max.	D2	EE	L1	L2	WH+A2	A2 <sup>1)</sup>	D1 max.	D2	EE	L1	L2	WH+A2
10 ... 50	25	93	17	G1/4	28	4	70.4	25	93	17	G1/4	28	4	74.3
51 ... 125	37						82.4	37						86.3
126 ... 175	49						94.4	49						98.3
176 ... 250	62						107.4	62						111.3
251 ... 300	74						119.4	74						123.3
301 ... 350	86						131.4	86						135.3
351 ... 375	87						132.4	87						136.3
376 ... 425	98						143.4	98						147.3
426 ... 475	110						155.4	110						159.3
476 ... 500	111	156.4	111	160.3										

1) The dimension corresponds to the E value (piston rod extension) of the drive

## Accessories

### Ordering data – Bellows kit

An extended piston rod (order code E) is absolutely essential when using a bellows kit → Ordering data – Modular product system.

The necessary dimension for order code E as a function of piston diameter and cylinder stroke as well as the corresponding bellows kit is indicated in the table below:

### Order example:

Selected standards-based cylinder:

DSBC-32-320-PPV-A-...

The dimension for the corresponding E value (see table):

112 mm

Complete order reference for standards-based cylinder:

DSBC-32-320-PPV-A-...-112E

The corresponding bellows kit:

DADB-V6-32-S301-350

Cylinder data			Bellows kit		Cylinder data			Bellows kit	
∅	Stroke	Dimension for E	Part no.	Type	∅	Stroke	Dimension for E	Part no.	Type
[mm]	[mm]	[mm]			[mm]	[mm]	[mm]		
32	10 ... 50	29	553271	DADB-V6-32-S10-50	40	10 ... 50	28	553291	DADB-V6-40-S10-50
	51 ... 125	47	553273	DADB-V6-32-S51-125		51 ... 125	43	553293	DADB-V6-40-S51-125
	126 ... 175	61	553275	DADB-V6-32-S126-175		126 ... 175	56	553295	DADB-V6-40-S126-175
	176 ... 250	80	553277	DADB-V6-32-S176-250		176 ... 250	72	553297	DADB-V6-40-S176-250
	251 ... 300	96	553279	DADB-V6-32-S251-300		251 ... 300	86	553399	DADB-V6-40-S251-300
	301 ... 350	112	553281	DADB-V6-32-S301-350		301 ... 350	100	553301	DADB-V6-40-S301-350
	351 ... 375	114	553283	DADB-V6-32-S351-375		351 ... 375	101	553303	DADB-V6-40-S351-375
	376 ... 425	130	553285	DADB-V6-32-S376-425		376 ... 425	115	553305	DADB-V6-40-S376-425
	426 ... 475	145	553287	DADB-V6-32-S426-475		426 ... 475	130	553307	DADB-V6-40-S426-475
476 ... 500	147	553289	DADB-V6-32-S476-500	476 ... 500	131	553309	DADB-V6-40-S476-500		
50	10 ... 50	28	553311	DADB-V6-50-S10-50	63	10 ... 50	28	553331	DADB-V6-63-S10-50
	51 ... 125	46	553313	DADB-V6-50-S51-125		51 ... 125	46	553333	DADB-V6-63-S51-125
	126 ... 175	56	553315	DADB-V6-50-S126-175		126 ... 175	56	553335	DADB-V6-63-S126-175
	176 ... 250	73	553317	DADB-V6-50-S176-250		176 ... 250	73	553337	DADB-V6-63-S176-250
	251 ... 300	86	553319	DADB-V6-50-S251-300		251 ... 300	86	553339	DADB-V6-63-S251-300
	301 ... 350	97	553321	DADB-V6-50-S301-350		301 ... 350	97	553341	DADB-V6-63-S301-350
	351 ... 375	105	553323	DADB-V6-50-S351-375		351 ... 375	105	553343	DADB-V6-63-S351-375
	376 ... 425	116	553325	DADB-V6-50-S376-425		376 ... 425	116	553345	DADB-V6-63-S376-425
	426 ... 475	126	553327	DADB-V6-50-S426-475		426 ... 475	126	553347	DADB-V6-63-S426-475
476 ... 500	134	553329	DADB-V6-50-S476-500	476 ... 500	134	553349	DADB-V6-63-S476-500		
80	10 ... 50	25	553351	DADB-V6-80-S10-50	100	10 ... 50	25	553371	DADB-V6-100-S10-50
	51 ... 125	37	553353	DADB-V6-80-S51-125		51 ... 125	37	553373	DADB-V6-100-S51-125
	126 ... 175	49	553355	DADB-V6-80-S126-175		126 ... 175	49	553375	DADB-V6-100-S126-175
	176 ... 250	62	553357	DADB-V6-80-S176-250		176 ... 250	62	553377	DADB-V6-100-S176-250
	251 ... 300	74	553359	DADB-V6-80-S251-300		251 ... 300	74	553379	DADB-V6-100-S251-300
	301 ... 350	86	553361	DADB-V6-80-S301-350		301 ... 350	86	553381	DADB-V6-100-S301-350
	351 ... 375	87	553363	DADB-V6-80-S351-375		351 ... 375	87	553383	DADB-V6-100-S351-375
	376 ... 425	98	553365	DADB-V6-80-S376-425		376 ... 425	98	553385	DADB-V6-100-S376-425
	426 ... 475	110	553367	DADB-V6-80-S426-475		426 ... 475	110	553387	DADB-V6-100-S426-475
476 ... 500	111	553369	DADB-V6-80-S476-500	476 ... 500	111	553389	DADB-V6-100-S476-500		

## Accessories

### Multi-position kit DPNC

Material:  
 Flange: Wrought aluminium alloy  
 Threaded pins, hex nuts: Galvanised steel

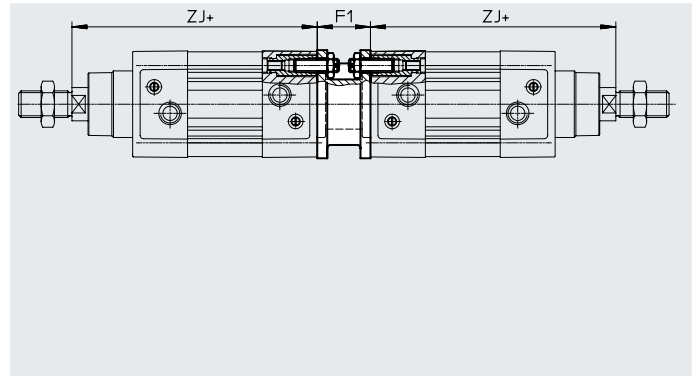

Dimensions and ordering data				Max. complete stroke [mm]	Weight [g]	Part no.	Type <sup>1)</sup>
For diam. [mm]	F1	ZJ					
		DSBC... +1.8	DSBC...-C				
32	27	119.1	164.1	500	292	174418	DPNC-32
40	27	133.9	186.9	800	410	174419	DPNC-40
50	32	141.8	208.8	800	335	174420	DPNC-50
63	28	157.1	233.1	700	390	174421	DPNC-63
80	38	173.6	268.6	1000	847	174422	DPNC-80
100	38	187.5	285.7	900	1200	174423	DPNC-100
125	48	225	349.3	1000	2102	174424	DPNC-125

1) Suitable for ATEX

#### Note

The maximum overall stroke length must not be exceeded when combining cylinders and multi-position kits.

### Connecting two cylinders with identical piston diameters to form a 3 or 4-position cylinder

A 3 or 4-position cylinder consists of two separate cylinders whose piston rods advance in opposing directions.

This means that, depending on the control and the stroke pattern, this type of cylinder can assume up to four positions, each of which

moves exactly to the stop. Note that when one end of the piston rod is fixed, the cylinder barrel executes the

movement. The line connections to the cylinder must therefore be flexible.

#### To achieve 3 positions

Two cylinders with identical stroke length must be connected together.

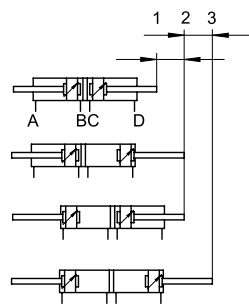

#### To achieve 4 positions

Two cylinders with different stroke lengths must be connected together.

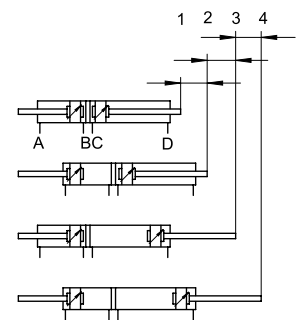

## Accessories

### Mounting kit DAVM

For lateral valve mounting, directly on the drive

Material:  
Mounting bracket, screws: Galvanised steel  
Slot nut: High-alloy stainless steel

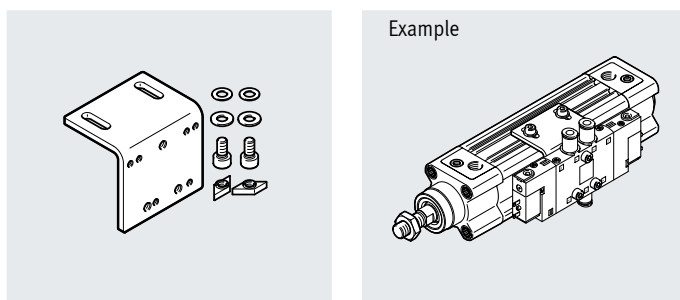

The hole pattern on the angle bracket enables solenoid valves to be attached on the right according to the assignment. The following table shows a few solenoid valves that are available.

Allocation table, mounting kit for solenoid valves

Mounting kit	Solenoid valve		
DAVM-MW-V1-32-V	CPE14	VUVG-L14	VUVS-L20
DAVM-MW-V1-50-V	CPE18, CPE24	VUVG-L18	VUVS-L25, VUVS-L30

### Recommended solenoid valves CPE

Data sheets → Internet: cpe

	For diam. [mm]	Mounting screw	Pneumatic connection	Function	Part no.	Type
	<b>Single solenoid</b>					
	32, 40	M4x20	G1/8	5/2-way valve	<b>196941</b>	<b>CPE14-M1BH-5L-1/8</b>
	50, 63	M4x25	G1/4		<b>163142</b>	<b>CPE18-M1H-5L-1/4</b>
	80, 100, 125	M5x30	G3/8		<b>163166</b>	<b>CPE24-M1H-5L-3/8</b>
	<b>Double solenoid</b>					
	32, 40	M4x20	G1/8	5/2-way valve	<b>196939</b>	<b>CPE14-M1BH-5J-1/8</b>
50, 63	M4x25	G1/4	<b>163143</b>		<b>CPE18-M1H-5J-1/4</b>	
80, 100, 125	M5x30	G3/8	<b>163167</b>		<b>CPE24-M1H-5J-3/8</b>	



### Accessories for solenoid valves CPE

	For valve	Cable length [m]	Part no.	Type
<b>Connecting cable NEBV/KMEB</b>				
Data sheets → Internet: nebv				
	CPE14	2.5	<b>8047679</b>	<b>NEBV-Z4WA2L-R-E-2.5-N-LE2-S1</b>
		5	<b>8047680</b>	<b>NEBV-Z4WA2L-R-E-5-N-LE2-S1</b>
	CPE18	2.5	★ <b>151688</b>	<b>KMEB-1-24-2.5-LED</b>
	CPE24	5	<b>151689</b>	<b>KMEB-1-24-5-LED</b>
		10	<b>193457</b>	<b>KMEB-1-24-10-LED</b>



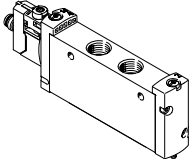

## Accessories

Recommended solenoid valves VUVG						Data sheets → Internet: vuvg
	For diam. [mm]	Mounting screw	Pneumatic connection	Function	Part no.	Type
	<b>Single solenoid</b>					
	32, 40	M3x20	G1/8	5/2-way valve	★ 8031508	VUVG-L14-M52-MT-G18-1R8L
	50, 63	M4x25	G1/4		★ 8031532	VUVG-L18-M52-MT-G14-1R8L
	<b>Double solenoid</b>					
	32, 40	M3x20	G1/8	5/2-way valve	★ 574230	VUVG-L14-B52-T-G18-1R8L
	50, 63	M4x25	G1/4		★ 8031533	VUVG-L18-B52-T-G14-1R8L

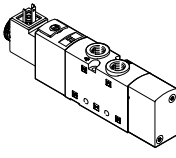
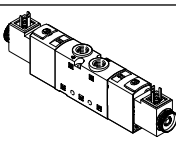
Accessories for solenoid valves VUVG						Data sheets → Internet: nebu
	For valve	Electrical connection	Cable length	Part no.	Type	
<b>Connecting cable NEBU</b>						
	VUVG-L14	Straight socket, M8x1, 3-pin	2.5 m	★ 541333	NEBU-M8G3-K-2.5-LE3	
	VUVG-L18		5 m	★ 541334	NEBU-M8G3-K-5-LE3	
		Angled socket, M8x1, 3-pin	2.5 m	★ 541338	NEBU-M8W3-K-2.5-LE3	
			5 m	★ 541341	NEBU-M8W3-K-5-LE3	

Recommended solenoid valves VUVS						Data sheets → Internet: vuvS
	For diam. [mm]	Mounting screw	Pneumatic connection	Function	Part no.	Type
	<b>Single solenoid, type C</b>					
	32, 40	M3x20	G1/8	5/2-way valve	★ 575263	VUVS-L20-M52-AD-G18-F7-1C1
					★ 575264	VUVS-L20-M52-MD-G18-F7-1C1
	50, 63	M4x20	G1/4		★ 575503	VUVS-L25-M52-AD-G14-F8-1C1
					★ 575511	VUVS-L25-M52-MD-G14-F8-1C1
	80, 100, 125	M5x30	G3/8		★ 575596	VUVS-L30-M52-AD-G38-F8-1C1
			★ 575604		VUVS-L30-M52-MD-G38-F8-1C1	
	<b>Double solenoid, type C</b>					
	32, 40	M3x20	G1/8	5/2-way valve	★ 575265	VUVS-L20-B52-D-G18-F7-1C1
	50, 63	M4x20	G1/4		★ 575518	VUVS-L25-B52-D-G14-F8-1C1
	80, 100, 125	M5x30	G3/8		★ 575611	VUVS-L30-B52-D-G38-F8-1C1

Accessories for solenoid valves VUVS						Part no.	Type	
<b>Plug socket MSSD</b>								
	<b>Plug pattern type C, to DIN EN 175301-803</b>							
	3-pin, screw terminal	Cable connector Pg7	0 ... 250 V AC/DC	IP65	★ 151687	MSSDEB		

 **Note**

Dimensions and ordering data  
→ Page 1

Accessories

Dimensions and ordering data

Download CAD data → [www.festo.com](http://www.festo.com)

DAVM-MW-V1-32-V

DAVM-MW-V1-50-V

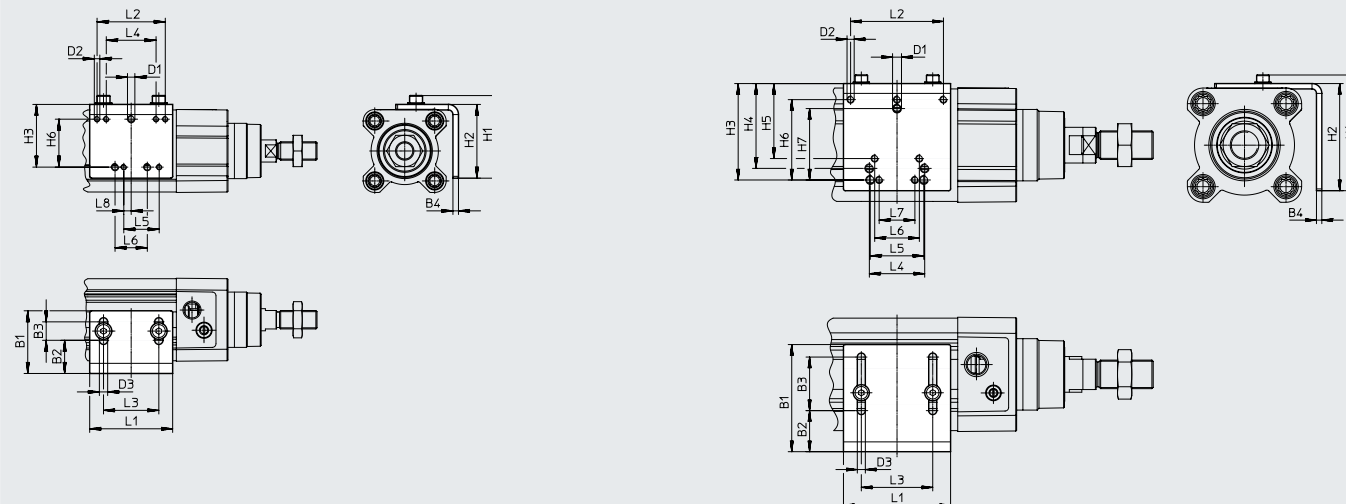

**Note**  
 Mounting is only possible on the side on which the pneumatic connections are located. Two slot nuts are included in the scope of delivery of the mounting kit. Additional slot nuts → page 62

For diam. [mm]	B1	B2	B3	B4	D1	D2	D3 ∅	H1	H2	H3	H4	H5	H6	H7
32	34	18	10	3	M4	M3	4.5	44.8	40	34	-	-	26	-
40														
50	60	23	30	3	M5	M4	4.5	64.8	60	54	47.5	42	45	40
63														
80														
100														
125														

For diam. [mm]	L1	L2	L3	L4	L5	L6	L7	L8	CRC1)	Weight [g]	Part no.	Type
32	45	37	30	27	19.2	17.5	-	4	1	76	2568514	DAVM-MW-V1-32-V
40												
50	60	52	40	31	30	25	20	-	1	160	2612128	DAVM-MW-V1-50-V
63												
80												
100												
125												

1) Corrosion resistance class CRC 1 to Festo standard FN 940070  
 Low corrosion stress. Dry internal application or transport and storage protection. Also applies to parts behind coverings, in the non-visible interior area, and parts which are covered in the application (e.g. drive trunnions).

## Accessories

## Ordering data – Guide units for fixed strokes (recirculating ball bearing guide only)

Stroke [mm]	Part no.	Type <sup>1)</sup>	
<b>For diam. 32 mm</b>			
10 ... 50	34493	FENG-32-50-KF	
10 ... 100	34494	FENG-32-100-KF	
10 ... 160	34495	FENG-32-160-KF	
10 ... 200	34496	FENG-32-200-KF	
10 ... 250	150289	FENG-32-250-KF	
10 ... 320	34497	FENG-32-320-KF	
10 ... 400	150290	FENG-32-400-KF	
10 ... 500	34498	FENG-32-500-KF	
<b>For diam. 50 mm</b>			
10 ... 50	34506	FENG-50-50-KF	
10 ... 100	34507	FENG-50-100-KF	
10 ... 160	34508	FENG-50-160-KF	
10 ... 200	34509	FENG-50-200-KF	
10 ... 250	34510	FENG-50-250-KF	
10 ... 320	34511	FENG-50-320-KF	
10 ... 400	150292	FENG-50-400-KF	
10 ... 500	34512	FENG-50-500-KF	
<b>For diam. 80 mm</b>			
10 ... 50	34521	FENG-80-50-KF	
10 ... 100	34522	FENG-80-100-KF	
10 ... 160	34523	FENG-80-160-KF	
10 ... 200	34524	FENG-80-200-KF	
10 ... 250	34525	FENG-80-250-KF	
10 ... 320	34526	FENG-80-320-KF	
10 ... 400	34527	FENG-80-400-KF	
10 ... 500	34528	FENG-80-500-KF	

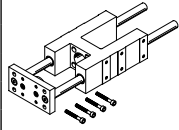

## Ordering data – Guide units for fixed strokes (plain-bearing guide only)





Stroke [mm]	Part no.	Type <sup>1)</sup>	
<b>For diam. 40 mm</b>			
10 ... 50	34499	FENG-40-50-KF	
10 ... 100	34500	FENG-40-100-KF	
10 ... 160	34501	FENG-40-160-KF	
10 ... 200	34502	FENG-40-200-KF	
10 ... 250	34503	FENG-40-250-KF	
10 ... 320	34504	FENG-40-320-KF	
10 ... 400	150291	FENG-40-400-KF	
10 ... 500	34505	FENG-40-500-KF	
<b>For diam. 63 mm</b>			
10 ... 50	34513	FENG-63-50-KF	
10 ... 100	34514	FENG-63-100-KF	
10 ... 160	34515	FENG-63-160-KF	
10 ... 200	34516	FENG-63-200-KF	
10 ... 250	34517	FENG-63-250-KF	
10 ... 320	34518	FENG-63-320-KF	
10 ... 400	34519	FENG-63-400-KF	
10 ... 500	34520	FENG-63-500-KF	
<b>For diam. 100 mm</b>			
10 ... 50	34529	FENG-100-50-KF	
10 ... 100	34530	FENG-100-100-KF	
10 ... 160	34531	FENG-100-160-KF	
10 ... 200	34532	FENG-100-200-KF	
10 ... 250	34533	FENG-100-250-KF	
10 ... 320	34534	FENG-100-320-KF	
10 ... 400	34535	FENG-100-400-KF	
10 ... 500	34536	FENG-100-500-KF	

## Ordering data – Guide units for variable strokes

For diam. [mm]	Stroke [mm]	With recirculating ball bearing guide		With plain-bearing guide		
		Part no.	Type <sup>1)</sup>	Part no.	Type <sup>1)</sup>	
	32	10 ... 500	34487	FENG-32-...-KF	34481	FENG-32-...-GF
	40	10 ... 500	34488	FENG-40-...-KF	34482	FENG-40-...-GF
	50	10 ... 500	34489	FENG-50-...-KF	34483	FENG-50-...-GF
	63	10 ... 500	34490	FENG-63-...-KF	34484	FENG-63-...-GF
	80	10 ... 500	34491	FENG-80-...-KF	34485	FENG-80-...-GF
	100	10 ... 500	34492	FENG-100-...-KF	34486	FENG-100-...-GF

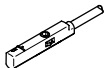
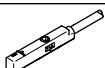
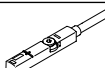
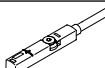
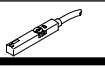
1) Suitable for ATEX

## Accessories



Ordering data – Proximity switches for T-slot, magneto-resistive							Data sheets → Internet: smt
	Type of mounting	Switching output	Electrical connection	Cable length [m]	Part no.	Type	
<b>N/O contact</b>							
	Insertable in the slot from above, flush with the cylinder profile, short design	PNP	Cable, 3-wire	2.5	★ 574335	SMT-8M-A-PS-24V-E-2,5-OE	
			Plug M8x1, 3-pin	0.3	★ 574334	SMT-8M-A-PS-24V-E-0.3-M8D	
			Plug M12x1, 3-pin	0.3	★ 574337	SMT-8M-A-PS-24V-E-0,3-M12	
		NPN	Cable, 3-wire	2.5	★ 574338	SMT-8M-A-NS-24V-E-2,5-OE	
			Plug M8x1, 3-pin	0.3	★ 574339	SMT-8M-A-NS-24V-E-0.3-M8D	
<b>N/C contact</b>							
	Insertable in the slot from above, flush with the cylinder profile, short design	PNP	Cable, 3-wire	7.5	★ 574340	SMT-8M-A-PO-24V-E-7.5-OE	
Ordering data – Proximity switches for T-slot, magnetic reed							Data sheets → Internet: sme
	Type of mounting	Switching output	Electrical connection	Cable length [m]	Part no.	Type	
<b>N/O contact</b>							
	Insertable in the slot from above, flush with the cylinder profile	Contacting	Cable, 3-wire	2.5	★ 543862	SME-8M-DS-24V-K-2,5-OE	
				5.0	★ 543863	SME-8M-DS-24V-K-5,0-OE	
			Cable, 2-wire	2.5	★ 543872	SME-8M-ZS-24V-K-2,5-OE	
				Plug M8x1, 3-pin	0.3	★ 543861	SME-8M-DS-24V-K-0,3-M8D
<b>N/C contact</b>							
	Insertable in the slot from above, flush with the cylinder profile	Contacting	Cable, 3-wire	7.5	★ 546799	SME-8M-DO-24V-K-7.5-OE	
Ordering data – Proximity sensor for T-slot, NAMUR							Data sheets → Internet: sdbt
	Type of mounting	Switching output	Electrical connection	Cable length [m]	Part no.	Type	
<b>N/O contact</b>							
	Insertable in the slot from above, flush with the cylinder profile	NAMUR	Cable, 2-wire	5	579071	SDBT-MS-20NL-ZN-E-5-LE-EX6	
				10	579072	SDBT-MS-20NL-ZN-E-10-LE-EX6	
Ordering data – Safety clip for ATEX zone							
	Description	For size	Part no.	Type			
	<ul style="list-style-type: none"> <li>Protects "equipment that is not intrinsically safe" against simple disconnection, here the plug of the proximity switch SMT and connecting cable NEBU</li> <li>ATEX category: gas: II 3G / dust: II 3D</li> </ul>	Plug M8x1	548067	NEAU-M8-GD			
Ordering data – Connecting cables							Data sheets → Internet: nebu
	Electrical connection, left	Electrical connection, right	Cable length [m]	Part no.	Type		
	Straight socket, M8x1, 3-pin	Cable, open end, 3-wire	2.5	★ 541333	NEBU-M8G3-K-2.5-LE3		
			5	★ 541334	NEBU-M8G3-K-5-LE3		
	Straight socket, M12x1, 5-pin	Cable, open end, 3-wire	2.5	★ 541363	NEBU-M12G5-K-2.5-LE3		
			5	★ 541364	NEBU-M12G5-K-5-LE3		
	Angled socket, M8x1, 3-pin	Cable, open end, 3-wire	2.5	★ 541338	NEBU-M8W3-K-2.5-LE3		
			5	★ 541341	NEBU-M8W3-K-5-LE3		
	Angled socket, M12x1, 5-pin	Cable, open end, 3-wire	2.5	541367	NEBU-M12W5-K-2.5-LE3		
			5	541370	NEBU-M12W5-K-5-LE3		

## Accessories

## Position transmitter

The position transmitter continuously senses the position of the piston.

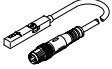
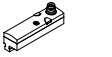
It has an analogue output with an output signal in proportion to the piston position.

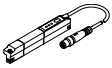
Ordering data – Position transmitters for T-slot								Data sheets → Internet: position transmitter	
	For diam.	Position measuring range	Analogue output		Type of mounting	Electrical connection	Cable length [m]	Part no.	Type
			[V]	[mA]					
	32 ... 125	0 ... 40	0 ... 10	–	Inserted in slot from above	Plug M8x1, 4-pin, in-line	0.3	<b>553744</b>	<b>SMAT-8M-U-E-0,3-M8D</b>
	32 ... 125	0 ... 50	0 ... 10	4 ... 20	Inserted into the slot lengthwise <sup>1)</sup>	Plug M8x1, 4-pin, lateral	–	<b>540191</b>	<b>SMAT-8E-S50-IU-M8</b>
						Plug M8x1, 4-pin, in-line	0.3	<b>570134</b>	<b>SMAT-8E-S50-IU-E-0,3-M8D</b>
	32 ... 125	0 ... 50	–	4 ... 20	Inserted in slot from above	Plug M8x1, 4-pin, in-line	0.3	<b>1531265</b>	<b>SDAT-MHS-M50-1L-SA-E-0.3-M8</b>
		0 ... 80						<b>1531266</b>	<b>SDAT-MHS-M80-1L-SA-E-0.3-M8</b>
		0 ... 100						<b>1531267</b>	<b>SDAT-MHS-M100-1L-SA-E-0.3-M8</b>
		0 ... 125						<b>1531268</b>	<b>SDAT-MHS-M125-1L-SA-E-0.3-M8</b>
		0 ... 160						<b>1531269</b>	<b>SDAT-MHS-M160-1L-SA-E-0.3-M8</b>

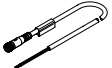
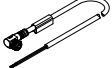

1) Can only be used in combination with DSBC...-D3.

Ordering data – Connecting cables				Data sheets → Internet: nebu	
	Electrical connection, left	Electrical connection, right	Cable length [m]	Part no.	Type
	Straight socket, M8x1, 4-pin	Cable, open end, 4-wire	2.5	<b>541342</b>	<b>NEBU-M8G4-K-2.5-LE4</b>
			5	<b>541343</b>	<b>NEBU-M8G4-K-5-LE4</b>
	Angled socket, M8x1, 4-pin	Cable, open end, 4-wire	2.5	<b>541344</b>	<b>NEBU-M8W4-K-2.5-LE4</b>
			5	<b>541345</b>	<b>NEBU-M8W4-K-5-LE4</b>

## Accessories

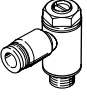
Data sheets → Internet: [grla](#)

Ordering data – One-way flow control valves				Part no.	Type
Connection		For tubing O.D.	Material		
Thread					
<b>For exhaust air</b>					
	G1/8	4	Metal version	★ 193143	GRLA-1/8-QS-4-D
		6		★ 193144	GRLA-1/8-QS-6-D
		8		★ 193145	GRLA-1/8-QS-8-D
	G1/4	6		★ 193146	GRLA-1/4-QS-6-D
		8		★ 193147	GRLA-1/4-QS-8-D
		10		★ 193148	GRLA-1/4-QS-10-D
	G3/8	6		★ 193149	GRLA-3/8-QS-6-D
		8		★ 193150	GRLA-3/8-QS-8-D
		10		★ 193151	GRLA-3/8-QS-10-D
	G1/2	12		★ 193152	GRLA-1/2-QS-12-D

Ordering data				Part no.	Type	PU <sup>1)</sup>
Description						
<b>Slot cover for T-slot</b>						
	Insertable, length 0.5 m			151680	ABP-5-S	2
<b>Slot nut for T-slot</b>						
	Inserted in the slot from above, thread M4			8028500	ABAN-8-1M4-5-P2	2
				8028501	ABAN-8-1M4-5-P100	100

1) Packaging unit